

Table of contents

Introduction	2
Instrumentation	4
Lights	12
Driver controls	23
Seating and safety restraints	45
Driving	60
Charging	69
Roadside emergencies	75
Cleaning	81
Maintenance and specifications	84
Customer assistance	97
Warranty information	103
Index	115

All rights reserved. Reproduction by any means, electronic or mechanical including photocopying, recording or by any information storage and retrieval system or translation in whole or part is not permitted without written authorization from Ford Motor Company. Ford may change the contents without notice and without incurring obligation.

Introduction

The following warning may be required by California law:

CALIFORNIA Proposition 65 Warning



Warning: This product contains or emits chemicals known to state of California to cause cancer and birth defects or other reproductive harm. In addition, certain fluids or certain products of component wear contain or emit chemicals knot to the state of California to cause cancer and birth defects or other reproductive harm.

ICONS

Indicates a safety alert.
Read the following section on *warnings*.



WARNINGS

Warnings provide information which may reduce the risk of personal injury to you and others.

BREAKING IN YOUR VEHICLE

There are no particular break-in schedules for the vehicle.

Proper charging and avoidance of over discharging of the batteries will enhance their lives and capacity. Make sure to read *Battery charging* in the Driving section of this manual and *Batteries* in the Maintenance and specifications section of this manual.

Introduction

These are some of the symbols you may see on your vehicle.

Safety Alert



Fasten Safety Belt



Brake System



Master Lighting Switch



INFORMATION ABOUT THIS GUIDE

The information found in this guide was in effect at the time of printing. Ford Motor Company and/or TH!NK Mobility, LLC may change the contents without notice and without incurring obligation.

Instrumentation

GAUGES

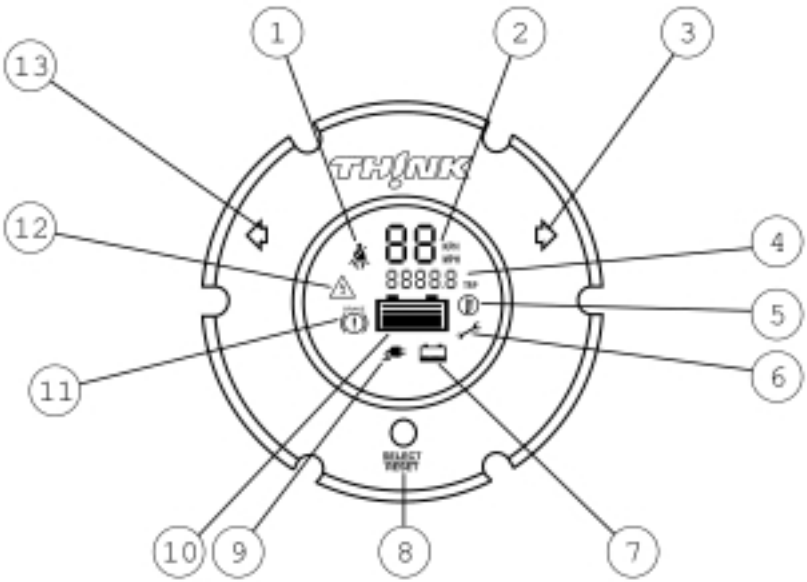

The instrument cluster LCD (liquid crystal display), referred to as the “gauge,” will be activated if any of the following conditions exist:

- Key switch is on
- Vehicle batteries are being recharged

1. Safety belt warning indicator

The safety belt warning icon will illuminate for 30 seconds after the vehicle is switched into D (Drive) mode.



2. Speedometer gauge LCD

A two-digit LCD gauge display shows the vehicle speed in either MPH or KPH,



depending on the selected mode. Vehicle speed is shown while in R (Reverse), T (Turf), and D (Drive) modes. The top speed of your vehicle in Drive mode is 25 mph (40 km/h) and 15 mph (24 km/h) in Turf mode.

Instrumentation

3. Right turn signal indicator



The arrow will flash when the turn signal lever is pushed up. If the indicator flashes at a fast rate, it has a malfunction, such as a burned out bulb.

4. Odometer/trip counter display



A five-digit LCD display shows the total accumulated miles traveled. The display may be changed to measure a particular trip distance. The drive mode selector switch must be in the T (Turf) or D (Drive) mode for this function. When the vehicle is restarted, the display will return to the last mode manually set.

Changing and resetting the modes

The odometer/trip modes can be changed by pressing the Select/Reset button on the instrument cluster. The word "TRIP" will be displayed next to the five-digit display when in Trip mode. To measure a specific trip mileage, with the drive mode selector switch in T (Turf) or D (Drive) reset the trip odometer by pushing and holding the Select/Reset button down for three seconds.

5. Drive system over-temperature indicator



This icon will illuminate if the drive system overheats. The drive normally 30 seconds, after which power will be limited and will remain limited until the drive system cools.

6. Service required indicator



The icon will illuminate when the vehicle has a malfunction in the motor controller. Cycle the service disconnect switch off and then back on. The service disconnect switch is located below and behind the parking brake lever within the seat stanchion (battery cover). It

Instrumentation

is a black rubber switch and faces the front of the vehicle. To access the service disconnect switch, remove the seat stanchion front cover, refer to Flooded type batteries in *Maintenance and specifications*. If the service required indicator is still on, take your vehicle to an authorized Dealer for the required maintenance to maintain your full warranty coverage.

7. Battery water reminder indicator

This icon indicates that your vehicle's batteries require a maintenance check of



the battery fluid levels. **Distilled water or demineralized water must be added as needed.** Your vehicle comes equipped with one of two types of batteries: “flooded”, requiring water level checks and maintenance refills; or the optional sealed maintenance free, for which no maintenance is required. This indicator will be disabled if your vehicle is equipped with sealed batteries. If you change the type of battery in your vehicle, the THINK dealer will need to change the battery setting in the gauge.

Resetting the battery water reminder indicator

Once the battery water has been checked, reset the reminder by pressing and holding the Select/Reset button for over three seconds while in the R (Reverse) mode. The reminder will only be reset during the following conditions: R (Reverse) mode is selected with the drive mode selector switch; instrument cluster gauge is in flooded battery mode.

Instrumentation

8. System Select/Reset button

This button is used to perform four functions.



- a. Each time the Select/Reset button is pressed and released in less than three seconds, the odometer/trip counter will switch between odometer and trip function displays. The drive mode selector switch must be in the D (Drive) or T (Turf) mode for this function.
- b. Pressing and holding the Select/Reset button, with the odometer in the trip mode, for over 3 seconds before releasing will reset the trip odometer to zero and return to the trip odometer function. The drive mode selector switch must be in the D (Drive) or T (Turf) mode for this function.
- c. Pressing and holding the Select/Reset button for over three seconds will reset the battery water reminder indicator. The drive mode selector switch must be in the R (Reverse) mode and the instrument cluster must be in “battery flooded mode” for this function.
- d. The Select/Reset button will allow you to display diagnostic code(s). To display the diagnostic code(s):
 - With the key in the OFF position, press and hold the Select/Reset button.
 - Select D (Drive) mode with the key.
 - Release the Select/Reset button.
 - Press and release the Select/Reset button to scroll through the diagnostic codes and their corresponding odometer value.
 - All codes will be deleted by holding the Select/Reset button for three seconds and releasing.
 - Exit Service mode by selecting the OFF mode with the key.
 - Press and release the Select/Reset button.

Instrumentation

The following is a list of diagnostic codes.

Fault Code	Description
05	Start switch fails to close.
06	Accelerator potentiometer pedal is depressed with no direction selected.
08	Accelerator input voltage too low on power up after initial drive mode selector switch closure.
09	Both forward and reverse direction switches are closed at the same time.
11	Start switch closed on power up after initial drive mode selector switch closure
15	Battery voltage is too low at initial drive mode selector switch closure.
16	Battery voltage is too high at initial drive mode selector switch closure.
23	Motor field current is high on start up in the reverse direction.
24	Motor field current is high on start up in the forward direction.
27	12V buss is too low.
41	Open thermal protector (TP) or transistor over-temperature.
42	Motor armature offset voltage is too high.
43	Motor armature offset voltage is too low.
44	Armature transistor did not turn off properly.
45	Armature transistor did not turn on properly.
46	“Look Ahead” test for A2 volts less than 12% of battery volts.
49	Motor field current is too low during the run mode.
51	Capacitor voltage is low before the line contactor closes.
57	Controller “motor current sensor” input too low while running.
75	Capacitor (1C) voltage too high during motoring
76	Capacitor (1C) voltage too high during regenerative braking.
90	Motor thermostat is open during control operation.

9. Battery charge indicator

The icon will illuminate when the vehicle is connected to an outside power



source to charge the batteries. The drive mode selector switch should be in the OFF position while the battery is charging.

Note: If this indicator is illuminated without the vehicle being charged there is a charger problem. The vehicle should be taken to an authorized TH!NK dealer.

10. Battery level indicator

The battery level indicator shows the power level remaining in the batteries. Be



sure the vehicle is not charging when checking the battery state of charge or the reading may be incorrect. The battery level indicator shows full whenever the vehicle is charging. Five bars are illuminated when the batteries have a full charge. At one bar, the battery outline will begin to flash. The flashing frequency will increase as the state of charge decreases. At low pack voltage, you may see either five bars or zero bars with a flashing outline. To maximize battery life, charge the vehicle as soon as possible when the outline begins to flash. When there are zero bars showing, the batteries have been discharged to the point where additional operation of your vehicle will reduce battery life. Charge the vehicle batteries immediately. If left uncharged, the batteries could discharge to the point where the battery charger will not turn on and battery damage may occur.

After a partial charge, the level may read higher than it actually is. Driving a few miles will cause the battery gauge to settle to an accurate level.

Instrumentation

11. Brake status indicator

This icon will illuminate if the emergency brake handle is not fully released, or if the brake fluid level is low. It will also flash while the park brake reminder is sounding.



12. Electrical leakage warning indicator

This icon will illuminate to warn that there is electrical “leakage” or short circuit to the vehicle frame. If the vehicle is wet or has recently been washed, allow the vehicle to fully dry and recheck for the indicator. If the indicator is still present, take your vehicle to an authorized TH!NK Dealer to correct the condition.



To avoid serious injury and/or death, never perform any vehicle service or maintenance while the electrical leakage warning indicator is illuminated.



This vehicle contains a high voltage electrical system. Serious injury, death, and/or property damage may result if this vehicle is not properly used, charged or serviced as stated in this manual. Read this owner’s guide prior to use, charging, or servicing this vehicle. Do not drill, cut, or modify any part of this vehicle, as high voltage wiring is present. Do not use jumper cables. Only charge this vehicle with an approved GFCI cord as stated in Battery charging.

Instrumentation

13. Left turn signal indicator



The arrow will flash when the turn signal lever is pushed down. If the indicator flashes at a fast rate, it has a malfunction, such as a burned out bulb.

Audible Indicators

Park brake reminder

The park brake reminder has a tone that sounds for 10 seconds when the drive mode selector switch is turned to the OFF position with the parking brake not set. It stops after 10 seconds or when the parking brake is engaged. During this time the vehicle is “active” with functional park brake reminder and the gauge will be active and backlit. After 10 seconds, the vehicle shuts down and park brake reminder is no longer functional.



To avoid serious injury, death, and/or property damage, always engage the parking brake before leaving the vehicle.

Reverse alarm

When the vehicle is in R (Reverse), a tone is generated to alert the driver and pedestrians.

Lights

HEADLAMP CONTROL

The headlamps are the larger inboard lamps on the front panel of the vehicle. The smaller outboard lamps are the front turn signals.



The headlamp switch also controls the tail lights. The tail lights are the larger inboard lamps integrated into the rear bumper. The smaller outboard lamps are the rear turn signal lamps.

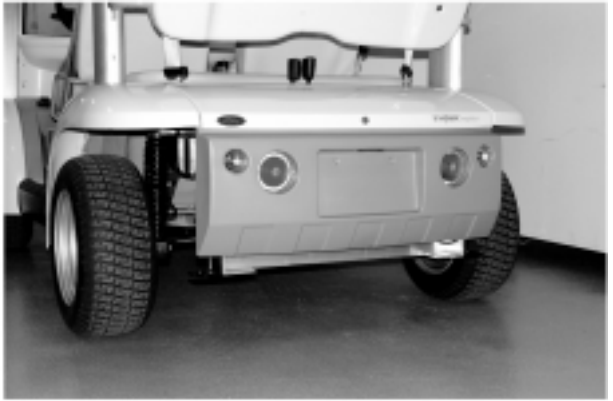

The headlamp switch is located on the lever on the left side of the steering column. The center section of the lever rotates to turn on the rear tail lamps, license plate lamps, and the headlamps.

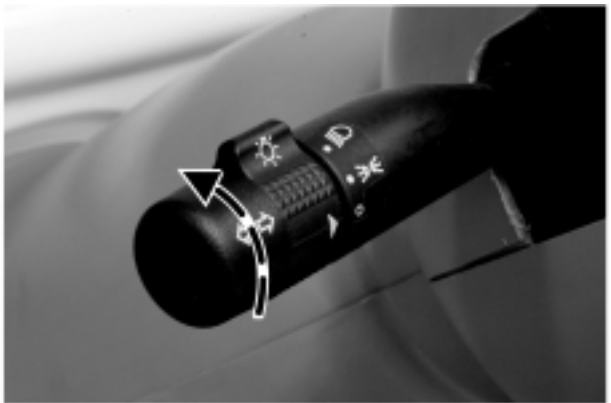

Lights

The headlamp switch can be identified by the bright bulb symbol.



Always remember to turn on your headlamps at dusk and dawn and during inclement weather. Failure to activate your headlamps under these conditions could result in a collision.

The OFF position is indicated on the lever by the O. When the switch arrowhead is aligned with the O symbol, the exterior lamps are off.



The lights will not operate in the key OFF mode.

The first position above the OFF position is the rear tail lamps and license plate lamp.



The second position above the OFF position will illuminate the headlamps while the rear tail lamps and license plate lamps remain on.



Pulling the headlamp switch rearward while it is in the OFF position will cause the headlamps to turn on as long as the switch is held rearward. There are no high beams on this vehicle. Pulling the headlamp switch rearward while it is in the ON position will NOT change the performance of the headlamps.

Lights

TURN SIGNAL CONTROL

The headlamp switch lever also controls the turn signals. Push down to activate the left turn signal, and push up to activate the right turn signal. The

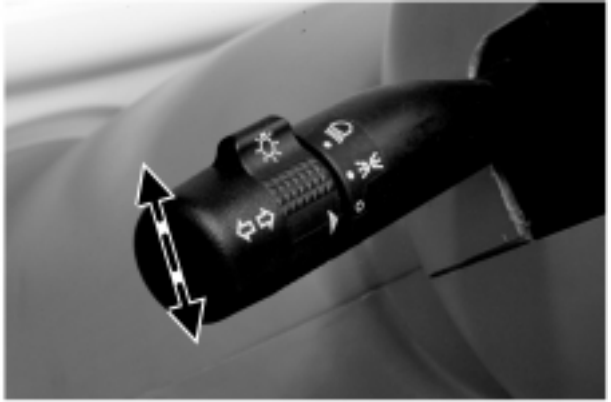

arrow indicator will flash on the instrument cluster indicating that the turn signal is on.

AIMING THE HEADLAMPS

The headlamps on your vehicle are properly aimed at the assembly plant.

If your vehicle has been in an accident the alignment of your headlamps should be checked by a qualified service technician.

Vertical aim adjustment

1. Park the vehicle on a level surface approximately 7.6 meters (25 feet) from a vertical wall or screen directly in front of it.

- (A) 2.43 meters (8 feet)
- (B) Height of top of lamp beam to ground
- (C) 6.09 meters (25 feet)
- (D) Horizontal reference line

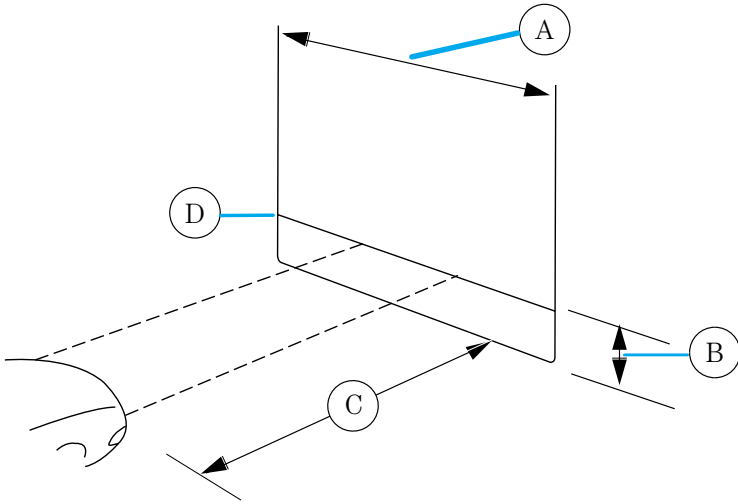

2. Turn on the headlamps to illuminate the wall or screen.

3. On the wall or screen you will observe an area of high intensity light. The top of the high intensity area should be .381 meters (2 ft 3 in) above the ground. If not, the beam will need to be adjusted by a qualified TH!NK technician.

BULB REPLACEMENT

Headlamps

To remove the headlamp bulb:

1. Remove the scrivet and the cowl tray panel.



Lights

2. Disconnect the headlamp electrical connector.

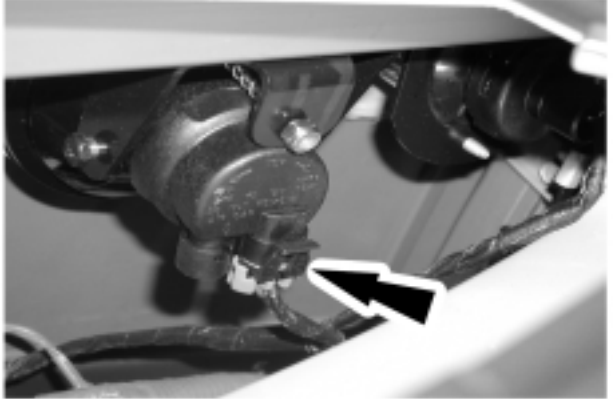

3. Rotate the headlamp bulb shield counterclockwise and flip down to access the bulb connectors.

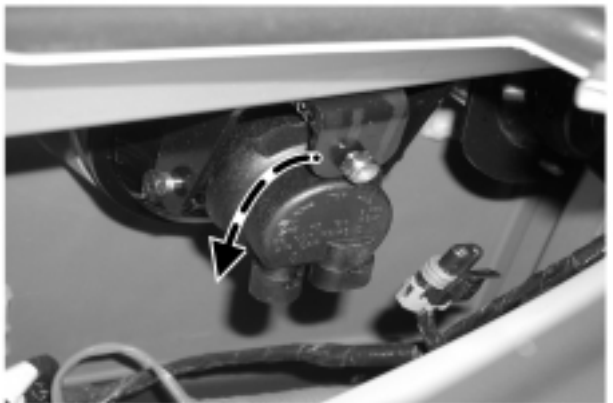

4. Pull the flat connector attached to the white wire from the headlamp bulb shield.

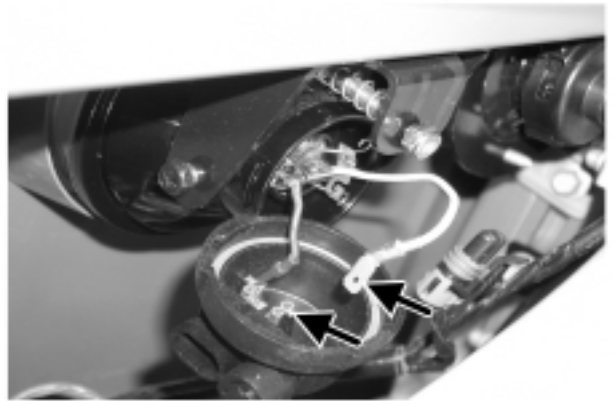

Lights

5. Push and squeeze the two bulb retainer wires to disengage them from the headlamp housing. Remove the headlamp bulb.

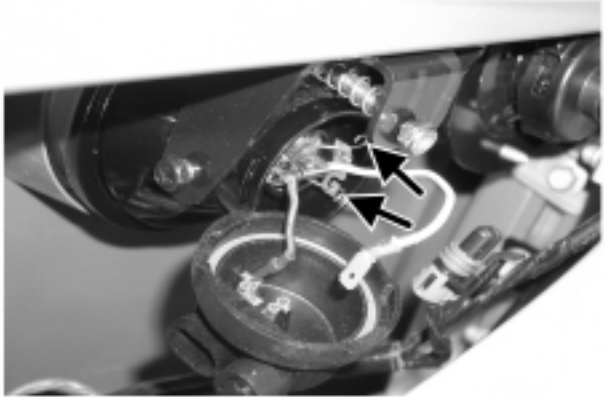

To install the headlamp bulb:



Handle the halogen headlamp bulb carefully and keep out of the children's reach. Grasp the bulb only by its metal base and do not touch the glass. The oil from your hand could cause the bulb to break the next time the headlamps are operated.

1. Install the headlamp bulb. Squeeze and push the two bulb retainer wires to engage them to the headlamp housing.



2. Push the flat connector attached to the white wire into the headlamp bulb shield.



Lights

3. Install and rotate the headlamp bulb shield clockwise.

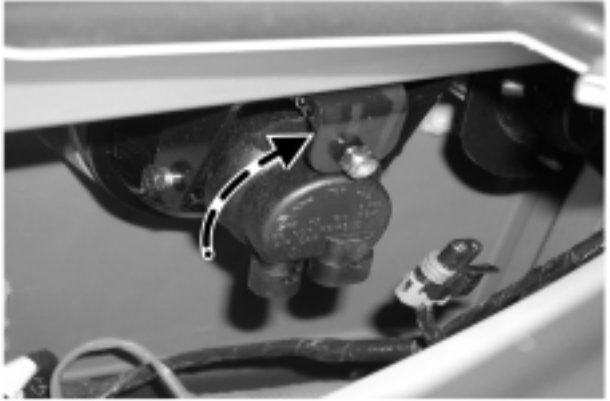

4. Connect the headlamp electrical connector.

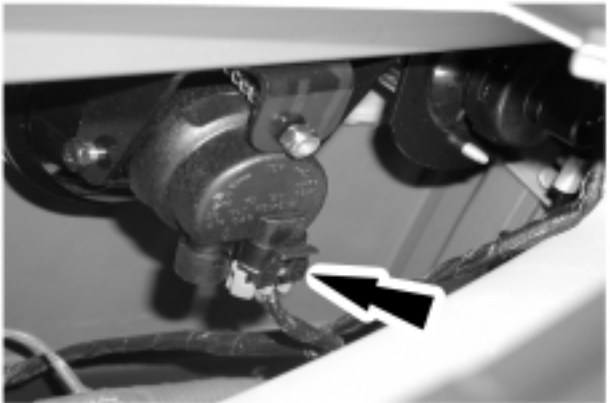

5. Install the cowl tray panel and the scrivet.



Replacing the front turn signals

1. Remove the scrivet and cowl tray panel. (Driver side shown; the passenger side is similar.)



2. Twist counterclockwise and remove the front turn signal bulb retainer.
3. Remove the bulb.
4. Install the new bulb.
5. Install the removed components.



Replacing the rear high-mount stop and reverse lamp bulbs

1. Remove the two screws and pull out the lamp assembly to expose the bulb sockets on the back.



Lights

2. Rotate the bulb socket counterclockwise and pull out to access the bulb.

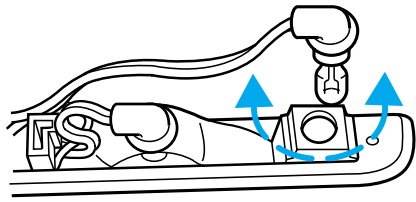
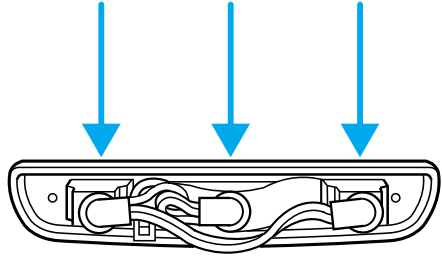

3. To remove the bulb, pull it straight out of the socket.

4. Insert a new bulb into the socket until it is fully seated.

5. Install the socket into the back of the lamp assembly and turn clockwise until it is locked into place.

6. Position the lamp assembly into the vehicle housing and install the two screws. Tighten the screws firmly, but do not over-tighten.

Over-tightening can cause damage to the lamp.

Replacing the rear turn signals

1. Unlock and remove the decklid (if equipped).

2. From inside the rear wheel housings, remove the six rear bumper bolts and carefully lower the bumper.



3. Twist counterclockwise and remove the rear turn signal bulb retainer.
4. Remove the bulb.



5. Install the new bulb.
6. Install the removed parts. Tighten the rear bumper bolts to 8–10 N•m.
7. Install and lock the decklid.

Replacing the tail lights/brake lights

Note: The bulb in the tail light/brake light assembly is not serviceable. The entire assembly must be replaced.

1. Unlock and remove the decklid.



2. Disconnect the electrical connector.

Lights

3. Remove the three screws and the rear turn signal assembly.

4. Connect the electrical connector and install the new lamp assembly.

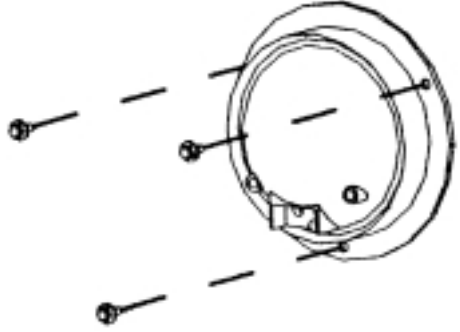

5. Tighten the screws firmly, but do not over-tighten.

6. Install and lock the decklid.

Using the right bulbs

Replacement bulbs are specified in the chart below.

Function	Number of bulbs	Trade number
Headlamp	2	H3
Backup lamp	2	906
License plate lamp	1	W5W
High-mount stop lamp	1	922
Turn signal lamp	4	7507/PY21W
All replacement bulbs are clear in color except where noted.		
To replace all instrument panel lights - see your Dealer.		

Driver controls

WINDSHIELD WIPER/WASHER

Front wiper control

The front windshield wiper is controlled by the lever mounted on the right side of the steering column.

To operate the windshield wiper, with the drive mode selector switch in R (Reverse), T (Turf) or D (Drive), push the lever up.

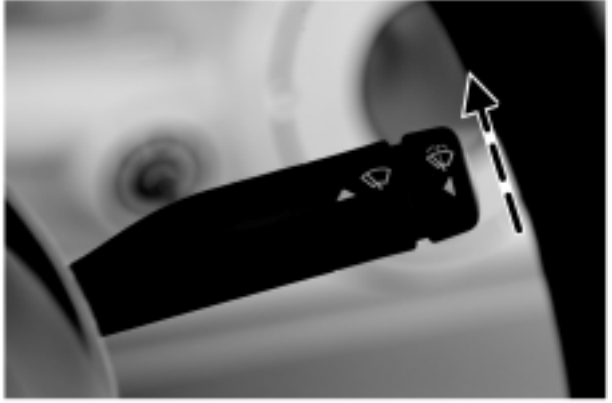

Washer

To operate the windshield washer, turn the wiper on, push the end of the lever in toward the steering column and hold it in for the desired length of spray. Release the lever to stop the washer and turn the wiper off.



Driver controls

Checking windshield washer fluid

To check the windshield washer fluid level:

1. Unlock and remove the hood.



2. Observe the level of fluid in the reservoir on the right side of the compartment.

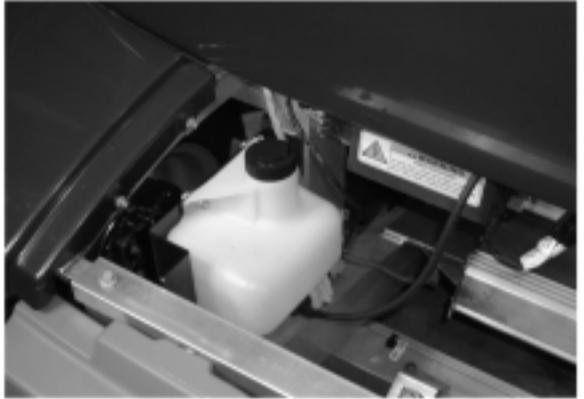

3. If necessary, unscrew the reservoir cap and fill with pre-mixed washer fluid.
4. Install the reservoir cap.
5. Install and lock the hood.

Checking the wiper blade

If the wiper operation results in streaky or obstructed vision, clean the blade with mild soap and water to remove any foreign material, grease or dirt. If the wiper operation still results in poor visibility, inspect the blade, the insert, and the arm.

- Confirm that the arm and blade are not bent or damaged. If any defect is found, the part must be replaced to assure proper operation.
- Confirm that the wiper blade insert is supple and pliable. If it has become hard, cracked, or split it must be replaced for proper operation.

Driver controls

SUN ROOF/ROOF VENT (IF EQUIPPED)

The sun roof/roof vent is located in the roof panel. Opening it increases air flow to the driver and front passenger.

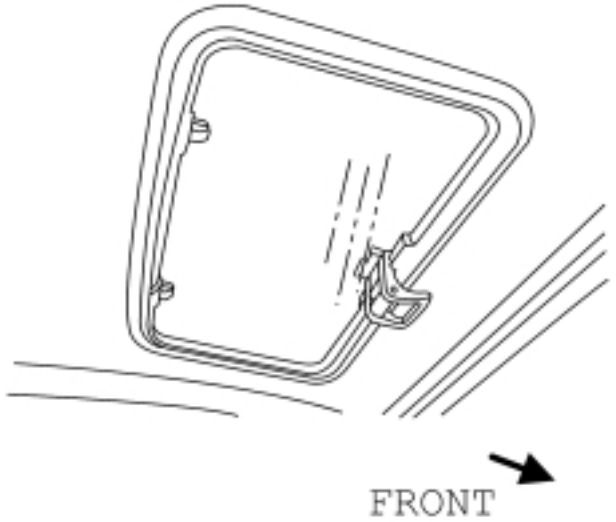

To open the sun roof/roof vent:

1. Pull down on the sun roof/roof vent handle to unlock the sun roof/roof vent.
2. Rotate the handle rearward and swivel up until it locks in one of the five raised positions.

To close the sun roof/roof vent:

1. Pull down on the sun roof/roof vent handle to unlock the sun roof/roof vent.
2. Rotate the handle forward and swivel up until it locks in the closed position.

Driver controls

HORN

To activate the horn, push one of the three horn contact points on the steering wheel.



CUPHOLDER

Your vehicle is equipped with a number of convenient cupholders, depending on which storage trays your vehicle has.

Driver side instrument panel storage tray with cupholder and storage compartments (Passenger side is similar.)



Optional cowl tray with sport package.

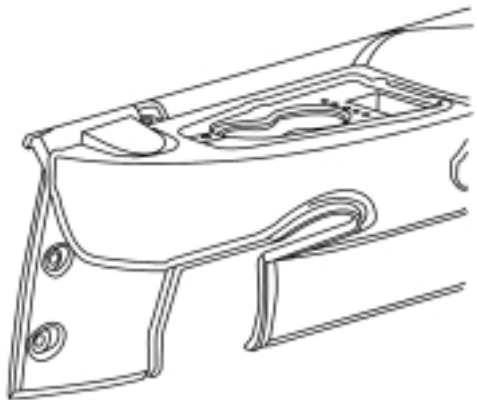

Driver controls

Rear cupholders
(4-passenger
only)

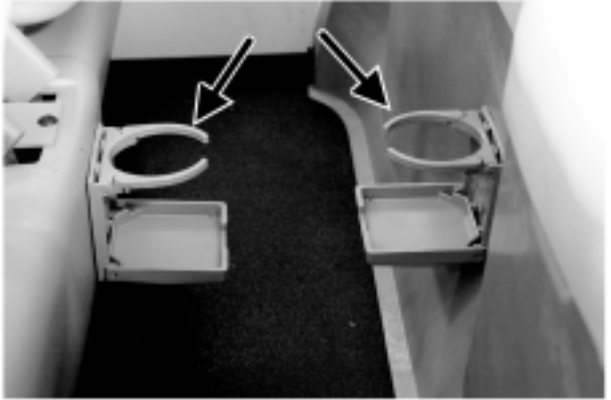

15 A POWER POINT (IF EQUIPPED)

The 15A power point is located on the passenger side of the instrument panel. The power point is operational at all times. For safety, there is

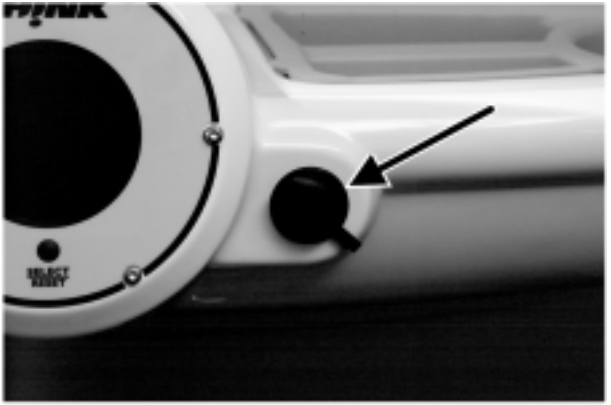

a rubber plug protecting the power point. To use the power point, remove the rubber plug and insert the desired accessory plug. Always keep the rubber plug inserted into the power point when not in use.

Note: The power point should not be used during battery charging.

MIRRORS

Interior rear view mirror

The interior rear view mirror is adjustable for both day and night use. To reduce the glare at night, use the manual switch at the base of the mirror to put the mirror in night mode.

Driver controls

Exterior mirror

The exterior rear view mirrors (right-hand mirror is optional) are adjusted manually. Your view should be adjusted so that the vehicle's rear tires are just visible in the bottom inside corner of the mirror. This will minimize any "blind spot" in your field of view.



Always confirm it is clear behind you before changing lanes or backing up to avoid a collision.

GOLF RACK (IF EQUIPPED)

To mount golf bags in the golf rack:

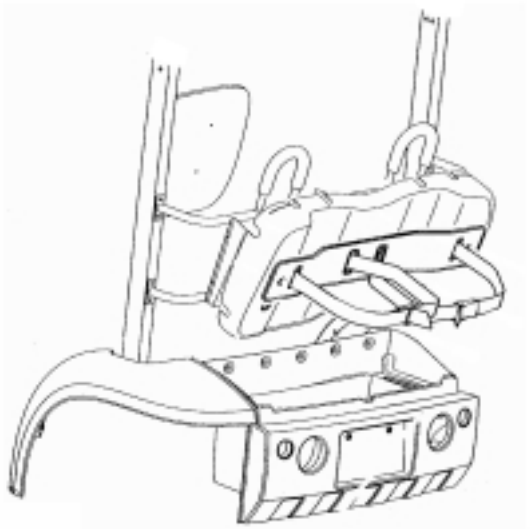

1. Unlock the decklid. To remove the decklid, lift and raise the decklid.

2. Pull rearward on the bag belt webbing release/locking lever.

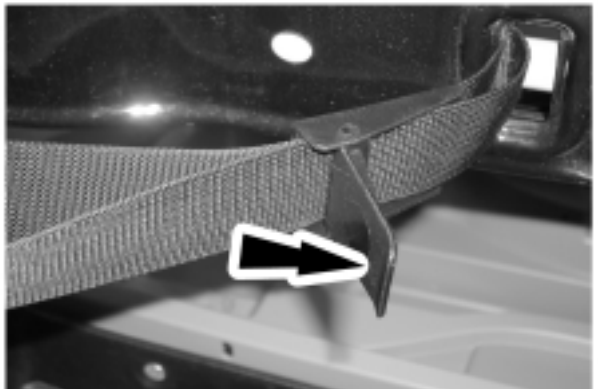

Driver controls

3. Pull the webbing out of the release/locking lever.
Note: The base of the golf bag should rest on the top of the golf bag tray.
4. Position the golf bag in the trunk area.
5. Route the webbing through the golf bag handle and through the release/locking lever.
6. Remove any slack from the webbing and lock the release/locking lever.

FLOOR MATS

The floor mats are fastened to the floor with scrivets that can be loosened and removed for cleaning under the floor mats.

SCORECARD HOLDER (IF EQUIPPED)

The scorecard holder is attached to the glove box door with magnets after attaching a magnetic disc to the glove box door.

STEREO (IF EQUIPPED)

For operating instructions for the stereo, please refer to the instructions provided with the unit.

Driver controls

SAND AND SEED BOTTLE AND HOLDER (IF EQUIPPED)

The sand and seed bottle holder is mounted to the left-hand side roof pillar.

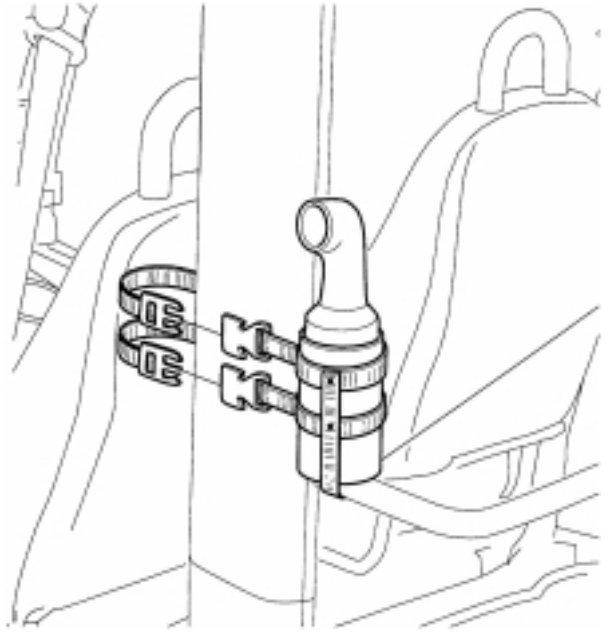

Driver controls

BALL AND CLUB WASHER (IF EQUIPPED)

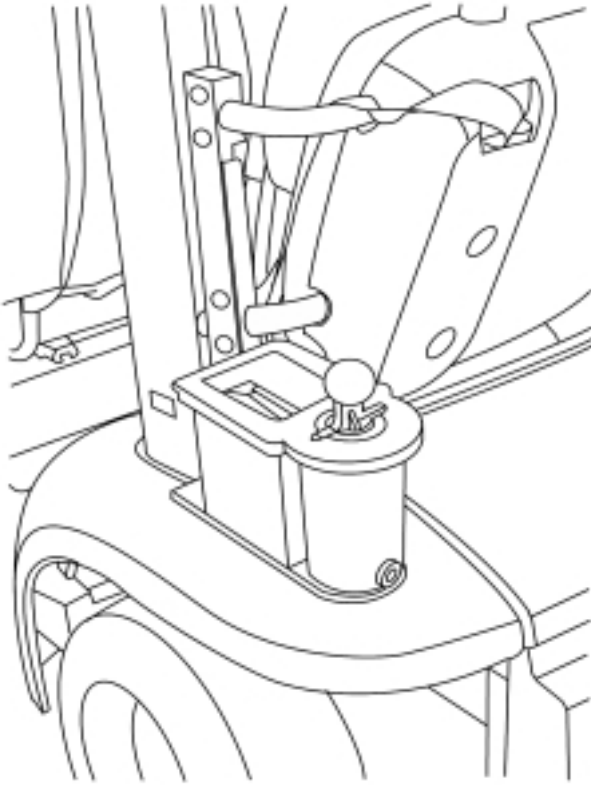

The ball and club washer is mounted to the left-hand side roof pillar.

To drain and fill the ball and club washer:

1. Remove the front and rear rubber plugs. Let the old water drain.

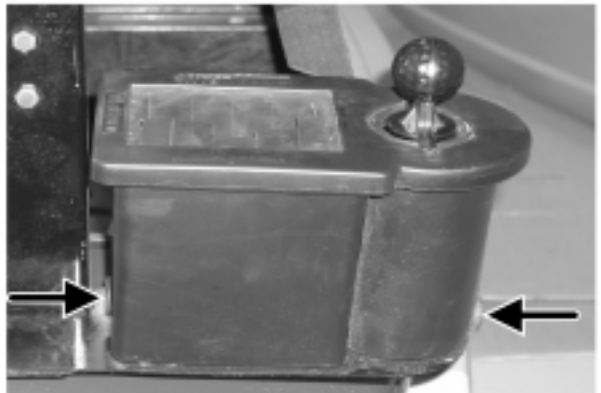

2. Remove the five screws from the bottom of the cover. Remove the cover.

Driver controls

3. Remove and rinse the cleaning brushes.



4. Rinse out any dirt or remaining soap.

5. Install the cleaning brushes.

6. Install the front and rear rubber plugs.

7. Fill with a water and soap solution.

8. Install the cover and screws. Tighten the screws, but do not overtighten.

COOLER (IF EQUIPPED)

The cooler is a removable folding soft cooler. On 4-passenger neighbors, the cooler is located under the rear seat. On 2-passenger neighbors, the cooler is located in the storage tray.



Driver controls

SWEATER BASKET (IF EQUIPPED)

The sweater basket is mounted to a bracket between the rear roof B-pillars.

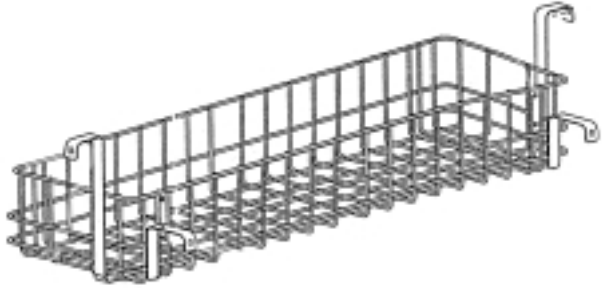

Note: The sweater basket is not designed to carry heavy objects.

SWEATER NET (IF EQUIPPED)

The sweater net drapes over the front seat and is held in place by a locking clasp that routes around the lower part of the seat frame.

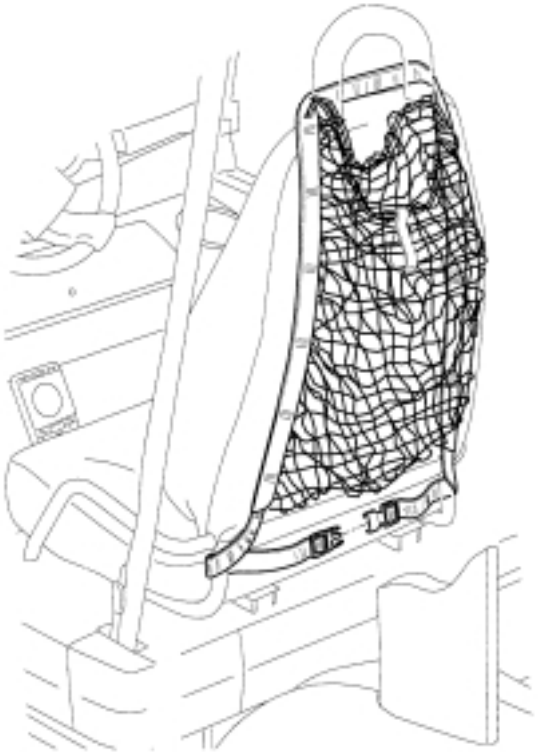

Place only soft, light-weight objects in the net. Hard, heavy objects in the net could cause injury in a collision.

Driver controls

TRUNK EXPANDER (IF EQUIPPED)

The trunk expander is a locking storage area that is inserted into the trunk to increase the amount of storage. The trunk expander is designed to hold two paper grocery bags in the bottom with three plastic bags hung from hooks mounted inside the trunk expander. There are two shelves to the right and left of the main area to hold other items.

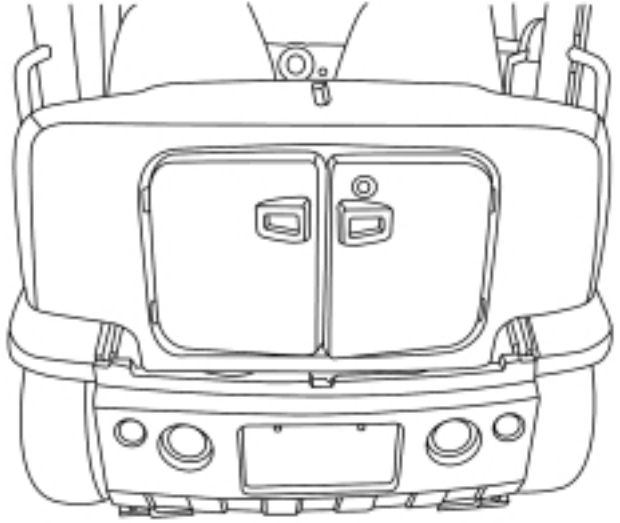

The hooks should not be loaded with over 8 lbs (3.6 kg).

The trunk should not be loaded to over 200 lbs (90.7 kg).

WEATHER ENCLOSURES (IF EQUIPPED)

The weather enclosures are designed to be installed on the vehicle to help shield the vehicle users and the interior of the vehicle from inclement weather.

To install the weather enclosure:

Side panels:

Note: Opening the front access panel zipper can help install the side panels.

1. Insert the side weather enclosure front hanger (“T” section) into the slot on the underside of the roof rail in front of the safety belt hanger bracket.

Driver controls

2. Slide the hanger forward until it reaches the front fender.

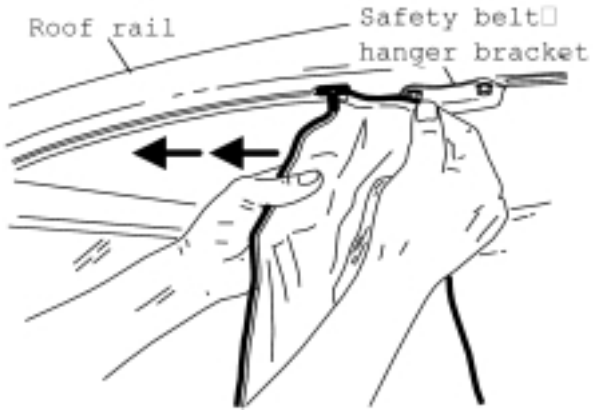

3. On four-passenger vehicles, insert the side weather enclosure rear hanger ("T" section) into the slot on the underside of the roof rail behind the safety belt hanger bracket.



4. Slide the hanger rearward until it reaches the B-pillar.

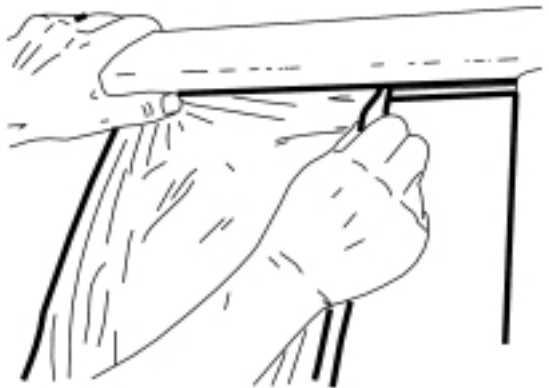

Driver controls

5. Wrap and fasten the large upper attaching strap around the B-pillar.

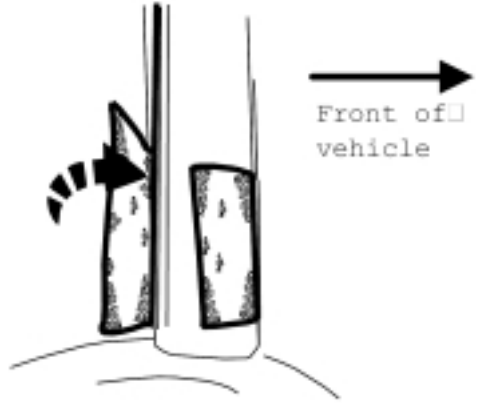

6. Wrap and fasten the two 1-inch attaching straps. Insert the attaching straps through the D-ring and fasten securely.

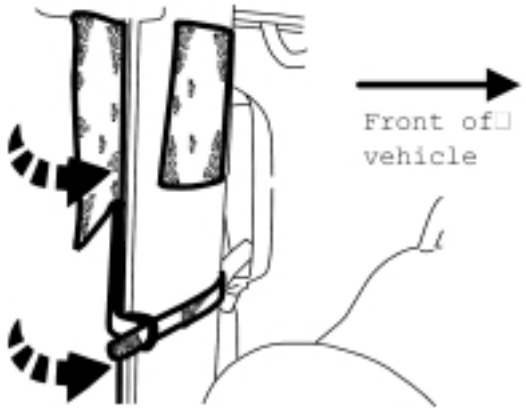

7. Attach the three mounting hooks to the openings in the frame rail.

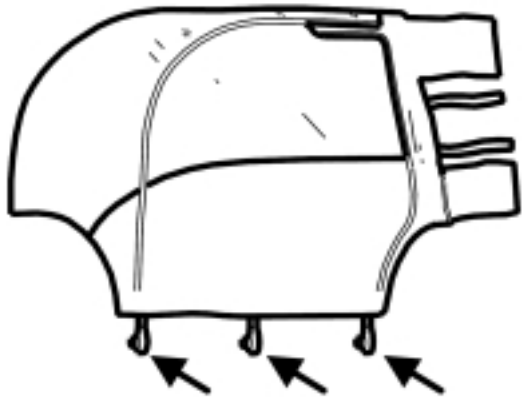

8. Repeat steps 1- 7 for the opposite side of the vehicle.

Driver controls

Rear panels:

9. Insert the rear weather enclosure hanger into the slot near the high-mount stop lamp.



10. Slide the hanger toward the B-pillar.

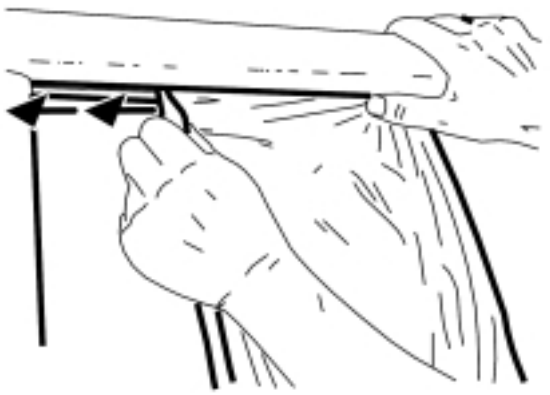

11. Zip the two rear weather enclosure to side weather enclosure zippers.



Driver controls

12. Attach the two rear mounting hooks to the rear fenders.

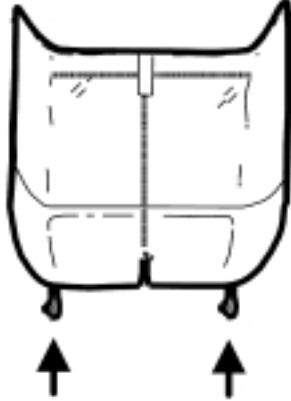

To remove the vehicle's weather enclosure:

1. Unfasten the two rear mounting hooks to the rear fenders.

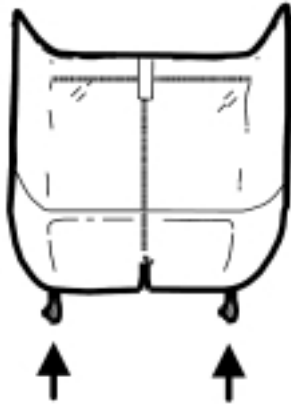

2. Unzip the two rear weather enclosure to side weather enclosure zippers

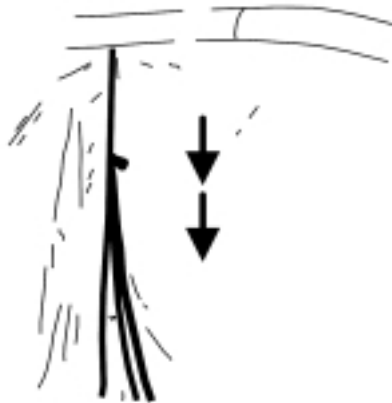

Driver controls

3. Slide the hanger away from the B-pillar.

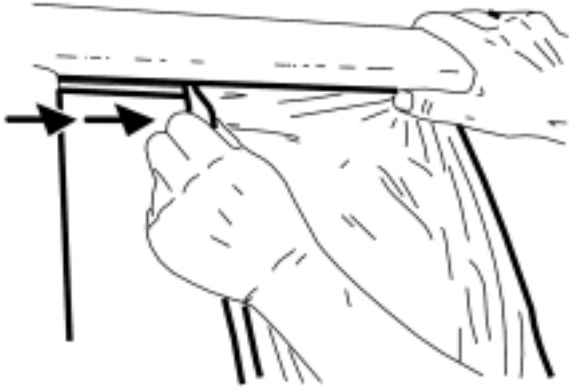

4. Remove the rear weather enclosure hangers from the slots behind the high-mount stop lamp.

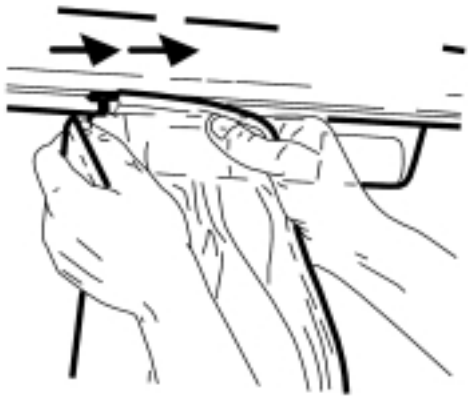

5. Unfasten the three side weather enclosure mounting hooks from the openings in the frame rail.

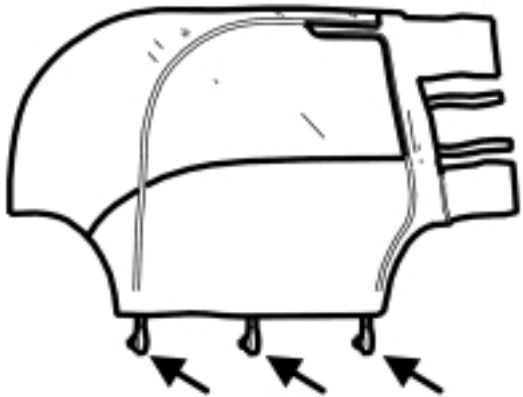

Driver controls

6. Pull apart the large upper and lower attaching straps.

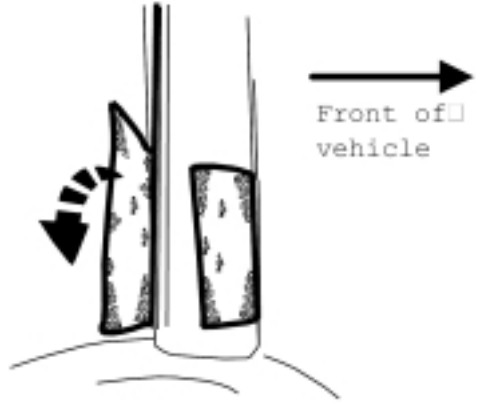

7. Pull apart the two 1-inch attaching straps.



8. Slide the hanger forward away from the B-pillar.

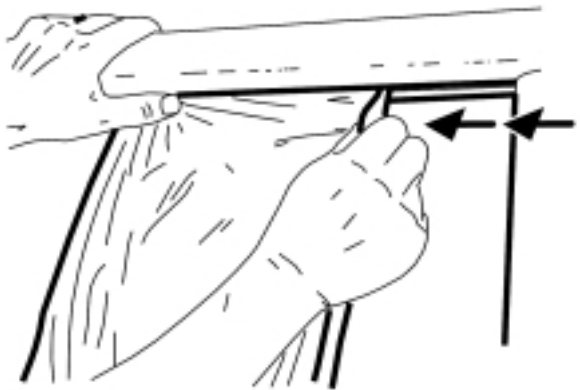

Driver controls

9. On four-passenger vehicles, remove the side weather enclosure rear hanger (“T” section) from the slot on the underside roof rail by the safety belt hanger bracket.



10. Slide the hanger away from the front fender.

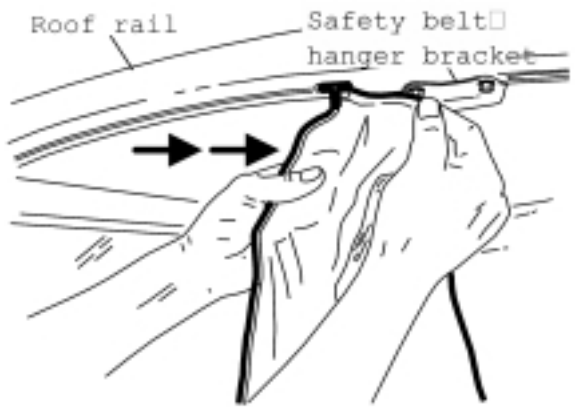

11. Remove the side weather enclosure front hanger from the slot on the underside of the roof rail in front of the safety belt hanger bracket.

Ventilation and access

Do not drive the vehicle with the weather enclosure side panels fully unzipped. They will drag on the ground damaging the panel.

Any stowed panels should not contact the tires or ground to prevent damage to the panels.

Driver controls

To open the front “windows” in the vehicle’s weather enclosure, refer to the illustration.

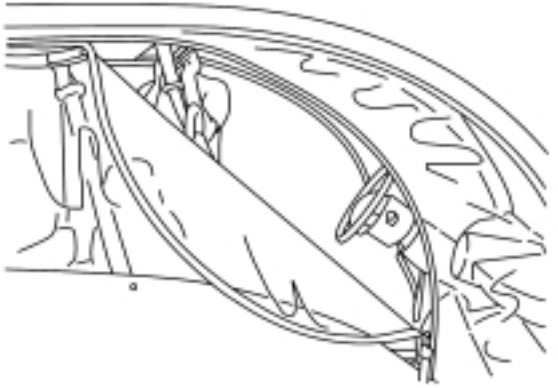

To open the rear “windows” on the 4-passenger vehicle’s weather enclosure, refer to the illustration.

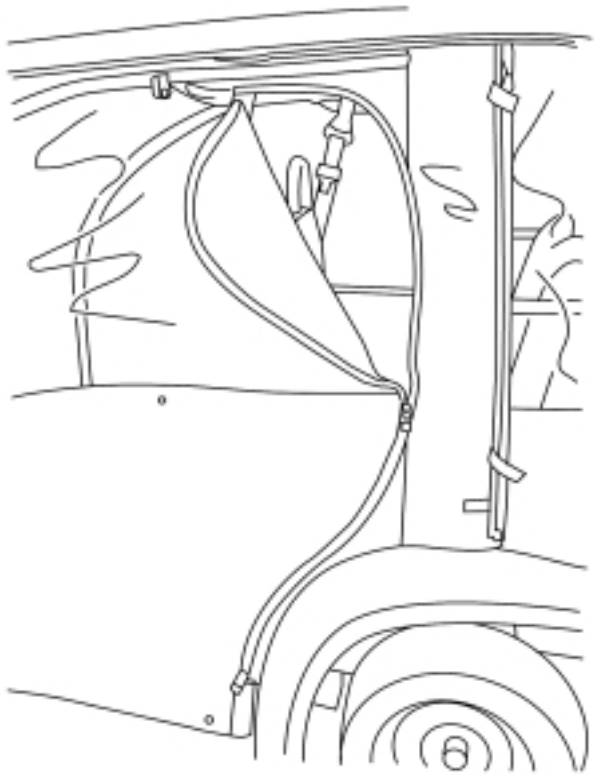

Driver controls

To open the front access in the vehicle's weather enclosure, refer to the illustration.



To open the front access on the 4-passenger vehicle's weather enclosure, refer to the illustration.



Driver controls

Storage

After thoroughly cleaning and completely drying the weather enclosures, you may store them in the storage bag as follows:

1. Lay the weather enclosure panels flat on top of each other on a clean, smooth surface.
2. Fold the bottom fabric onto the clear plastic.
3. From the front or rear, roll it up and slide it into the storage bag.

VEHICLE COVER (IF EQUIPPED)

The vehicle cover drapes over the vehicle and is held in place by elastic. It can be locked using a cable and lock.



There are hydrogen gases around the batteries that can explode if exposed to flames, sparks, or lit cigarettes. The amount of hydrogen gas is increased during battery charging. An explosion could result in personal injury or vehicle damage.



Do not charge the batteries with the weather enclosure closed or the vehicle cover in place. A build-up of hydrogen gas can result which can cause an explosion. The charging area should be well ventilated.

Seating and safety restraints

SEATING

Head restraints

The head restraints on the front and rear seats are in a fixed position and cannot be adjusted or removed.

Front seat



Never adjust the driver's seat when the vehicle is moving.



Always make sure that both front seat bottoms are latched down into place before operating the vehicle.

The driver's seat is on a track and is adjustable forward and back. To move the seat forward or back, slide the lever at the side of the seat to the rear and slide the seat to the desired position. Release the lever to lock the seat in the new position.

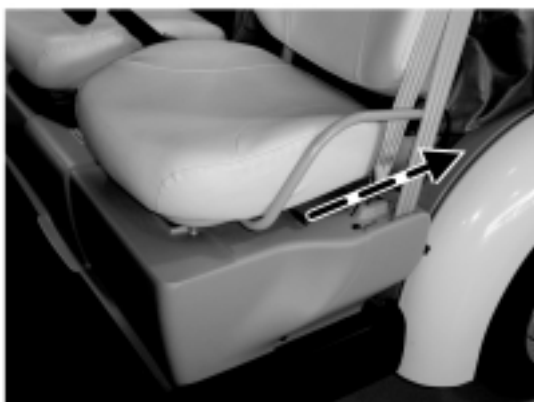

The front passenger seat is not adjustable.

REAR SEATS (IF EQUIPPED)



Always make sure that the rear seat cushion is locked down into place before operating the vehicle.

The rear seat is not adjustable. The cushion lifts up to access the rear seat storage compartment.

Seating and safety restraints

SAFETY RESTRAINTS

Safety restraints precautions



Always make sure that both front seat bottoms are latched down into place before operating the vehicle.



To reduce the risk of injury, make sure children sit where they can be properly restrained.



Never let a passenger hold a child on his or her lap while the vehicle is moving. The passenger cannot protect the child from injury in a collision.



All occupants of the vehicle, including the driver, should always properly wear their safety belts.



It is extremely dangerous to ride in a cargo area, inside or outside of a vehicle. In a collision, people riding in these areas are more likely to be seriously injured or killed. Do not allow people to ride in any area of your vehicle that is not equipped with seats and safety belts. Be sure everyone in your vehicle is in a seat and using a safety belt properly.



In a rollover crash, an unbelted person is significantly more likely to die than a person wearing a safety belt.

Seating and safety restraints



Each seating position in your vehicle has a specific safety belt assembly which is made up of one buckle and one tongue that are designed to be used as a pair. 1) Use the shoulder belt on the outside shoulder only. Never wear the shoulder belt under the arm. 2) Never swing the safety belt around your neck over the inside shoulder. 3) Never use a single belt for more than one person.

Combination lap and shoulder belts

1. Insert the belt tongue into the proper buckle (the buckle closest to the direction the tongue is coming from) until you hear a snap and feel it latch. Make sure the tongue is securely fastened in the buckle.



2. To unfasten, push the release button on the buckle and pull the tongue out of the buckle.

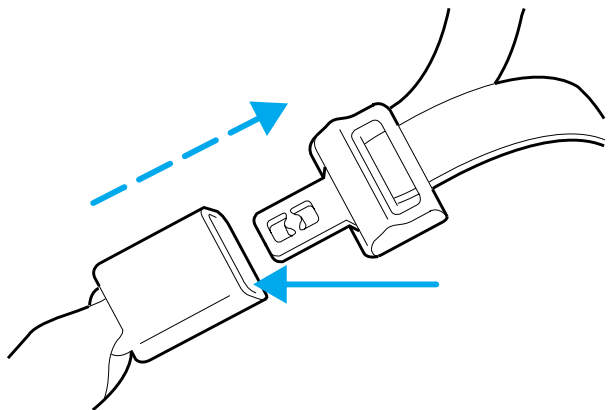

Seating and safety restraints

Vehicle sensitive mode

The vehicle sensitive mode is the normal retractor mode, allowing free shoulder belt length adjustment to your movements, and locking in response to vehicle movement. If the driver brakes suddenly or turns a corner sharply, or the vehicle receives an impact of approximately 8 km/h (5 mph) or more, the combination safety belts will lock to help reduce forward movement of the driver and passenger.

Cinch tongue mode

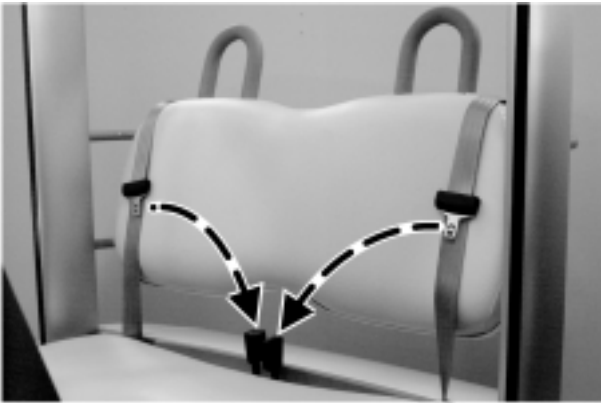

The front passenger and rear seat (if equipped) have cinch tongues to help install a child safety seat tightly.

The cinch tongue will slide up and down the belt webbing when the belt is in the stowed position or while putting safety belts on. When the cinch tongue of the lap/shoulder combination safety belt is latched into the buckle, the cinch tongue will allow the lap portion to become shorter, but holds the webbing in place to keep the lap belt from becoming longer.

Before you can reach and latch a combination lap and shoulder belt having a cinch tongue into the buckle, you may have to lengthen the lap belt portion of it.

Seating and safety restraints

1. To lengthen the lap belt, pull some webbing out of the shoulder belt retractor.
2. While holding the webbing below the tongue, grasp the tip (metal portion) of the tongue so that it is parallel to the webbing and slide the tongue upward.
3. Provide enough lap belt length so that the tongue can reach the buckle.

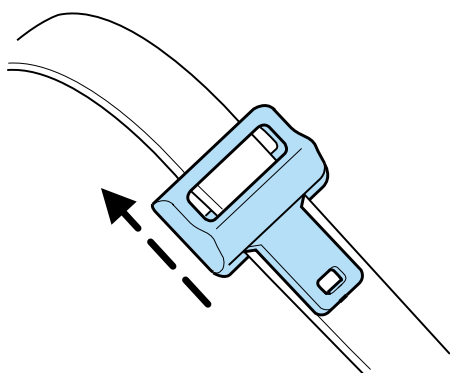

How to fasten the cinch tongue

1. Pull the combination lap and shoulder belt from the retractor so that the shoulder belt portion of the safety belt crosses your shoulder and chest.
2. Be sure the belt is not twisted. If the belt is twisted, remove the twist.
3. Insert the belt tongue into the proper buckle for your seating position until you hear a snap and feel it latch.
4. Make sure the tongue is securely fastened to the buckle by pulling on the tongue.



The lap belt should fit snugly and as low as possible around the hips, not across the waist.



Front and rear seat occupants, including pregnant women, should wear safety belts for optimum protection in an accident.

Seating and safety restraints



Each seating position in your vehicle has a specific safety belt assembly which is made up of one buckle and one tongue that are designed to be used as a pair. 1) Use the shoulder belt on the outside shoulder only. Never wear the shoulder belt under the arm. 2) Never swing the safety belt around your neck over the inside shoulder. 3) Never use a single belt for more than one person.

While you are fastened in the safety belt, the combination lap/shoulder belt with a cinch tongue adjusts to your movement. However, if you brake hard, turn hard, or if your vehicle receives an impact of 8 km/h (5 mph) or more, the safety belt will lock to help reduce your forward movement.

Safety belt extension assembly

If the safety belt is too short when fully extended, there is a 20 cm (8 inch) safety belt extension assembly.

Use only extensions manufactured by the same supplier as the safety belt. Manufacturer identification is located at the end of the webbing on the label. Also, use the safety belt extension only if the safety belt is too short when fully extended. Do not use extensions to change the fit of the shoulder belt across the torso.

Safety belt maintenance

Check the safety belt systems periodically to make sure that they work properly and are not damaged.

All safety belt assemblies, including retractors, buckles, child safety seat tether bracket assemblies (if equipped), and attaching hardware, should be inspected after any collision. Th!nk recommends that all safety belt assemblies used in vehicles involved in a collision be replaced. However, if the collision was minor and a qualified technician finds that the belts do not show damage and continue to operate properly, they do not need to be replaced. Safety belt assemblies not in use during a collision should

Seating and safety restraints

also be inspected and replaced if either damage or improper operation is noted.



Failure to inspect and if necessary replace the safety belt assembly following a collision or in the event of a damaged or worn belt, could result in severe personal injuries in the event of a collision.

CHILD RESTRAINTS

Important precautions



You are required by law to use safety restraints for children in the United States. If small children ride in your vehicle (generally children who are four years old or younger and who weigh 18 kg [40 lbs] or less), you must put them in safety seats made especially for children. Check your local state laws for specific requirements regarding the safe transportation of children in your vehicle.



Never let a passenger hold a child on his or her lap while the vehicle is moving. The passenger cannot protect the child from injury in a collision.



Always follow the instructions and warnings that come with any infant or child restraint you might use.

Children and safety belts

If the child is the proper size, restrain the child in a safety seat.

Children who are too large for child safety seats (as specified by your child safety seat manufacturer) should always wear safety belts.

Moving the child closer to the center of the vehicle may help provide a good shoulder belt fit.

Seating and safety restraints

To improve the fit of lap and shoulder belts on children who have outgrown child safety seats, TH!NK Mobility recommends use of a belt-positioning booster seat that is labeled as conforming to all applicable federal motor vehicle safety standards. Belt—positioning booster seats raise the child and provide a shorter, firmer seating cushion that encourages safer seating posture and a better fit of lap and shoulder belts.

A belt-positioning booster should be used if the shoulder belt rests in front of the child's face or neck, or if the lap belt does not fit snugly on both thighs, or if the thighs are too short to let the child sit all the way back on the seat cushion when the lower legs hang over the edge of the seat cushion. You may wish to discuss the special needs of your child with your pediatrician.

Follow all of the important safety restraint precautions that apply to adult passengers in your vehicle.



Do not leave children, unreliable adults, or pets unattended in your vehicle.

SAFETY SEATS FOR CHILDREN



Child and infant or child safety seats

Use a safety seat that is recommended for the size and weight of the child. Carefully follow all of the manufacturer's instructions with the safety seat you put in your vehicle. If you do not install and use the

Seating and safety restraints

safety seat properly, the child may be injured in a sudden stop or collision.

When installing a child safety seat:

- Use the correct safety belt buckle for that seating position.
- Insert the belt tongue into the proper buckle until you hear a snap and feel it latch. Make sure the tongue is securely fastened in the buckle.
- Keep the buckle release button pointing up and away from the safety seat, with the tongue between the child seat and the release button, to prevent accidental unbuckling.
- Place seatback in upright position.



Carefully follow all of the manufacturer's instructions included with the safety seat you put in your vehicle. If you do not install and use the safety seat properly, the child may be injured in a sudden stop or collision.

Installing child safety seats in cinch tongue combination lap and shoulder belt seating positions (typical seat shown)

The belt webbing below the tongue is the lap portion of the combination lap/shoulder belt, and the belt webbing above the tongue is the shoulder belt portion of the combination lap/shoulder belt.

1. Position the child safety seat in a seat with a combination lap and shoulder belt.

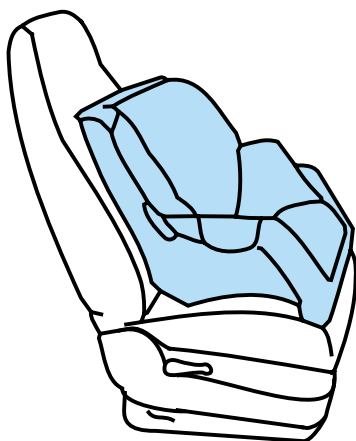

Seating and safety restraints

2. Grasp the belt webbing above the tongue and pull as much of the belt out of the retractor as necessary to route the belt according to the child seat manufacturer's instructions. Hold the belt out.

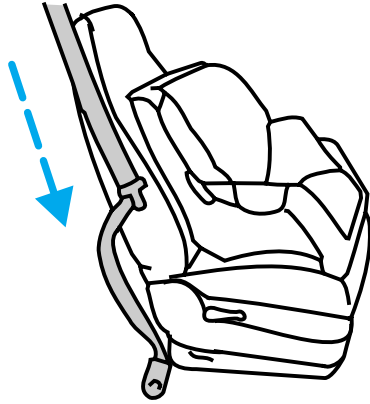

3. While holding the shoulder and lap portions together, route the tongue and webbing through the child seat according to the child seat manufacturer's instructions. Be sure that the belt webbing is not twisted.

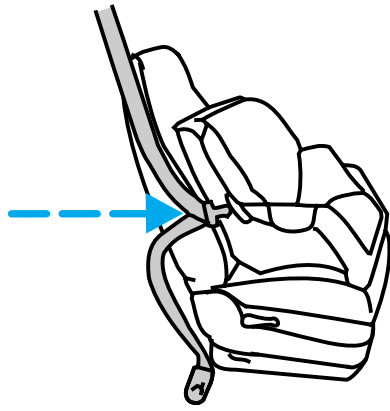

4. Insert the belt tongue into the proper buckle for that seating position until you hear a snap and feel it latch. Make sure the tongue is securely latched to the buckle by pulling on the tongue.

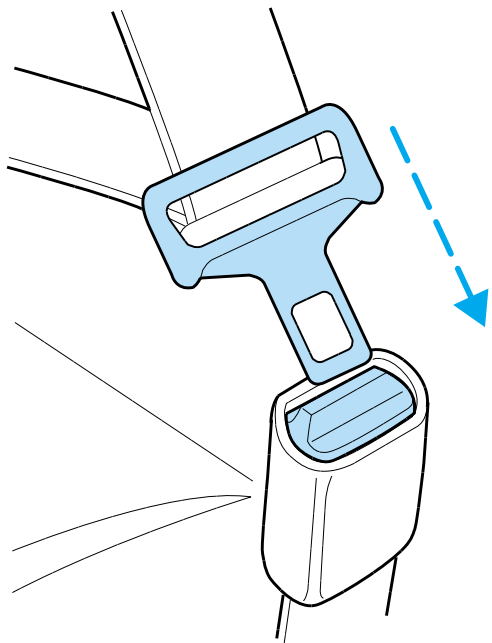

Seating and safety restraints

5. While pushing down with your knee on the child seat, pull up on the shoulder belt portion to tighten the lap belt portion of the combination lap and shoulder belt.

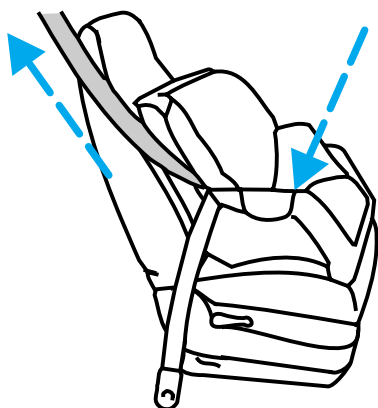

6. Allow the safety belt to retract and remove any slack in the belt to securely tighten the child safety seat in the vehicle.

7. Before placing the child into the child seat, forcibly tilt the child seat forward and back to make sure that the seat is held securely in place.

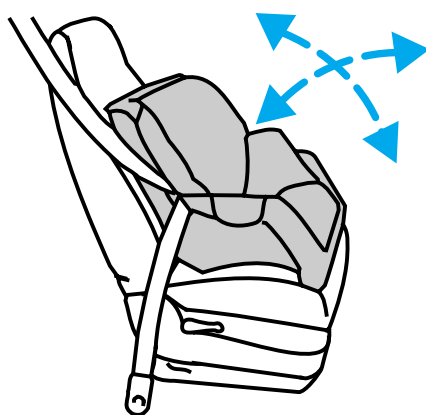

8. Check from time to time to be sure that there is no slack in the lap/shoulder belt. The shoulder belt must be snug to keep the lap belt tight during a collision.

Attaching child safety seats with tether straps

Most new forward-facing child safety seats include a tether strap which goes over the back of the seat and hooks to an anchoring point. Tether straps are available as an accessory for many older safety seats. Contact the manufacturer of your child seat for information about ordering a tether strap.

Seating and safety restraints

The optional LATCH equipped passenger seat is equipped with built-in tether strap anchors located behind the seat as described below.

The tether anchor (if equipped) in your vehicle is located at the bottom of the front passenger seatback.



Attach the tether strap only to the appropriate tether anchor as shown. The tether strap may not work properly if attached somewhere other than the correct tether anchor.

1. Position the child safety seat on the seat cushion.
2. Route the child safety seat tether strap over the back of the seat and between the head restraint posts.



Seating and safety restraints

3. Locate the correct anchor.

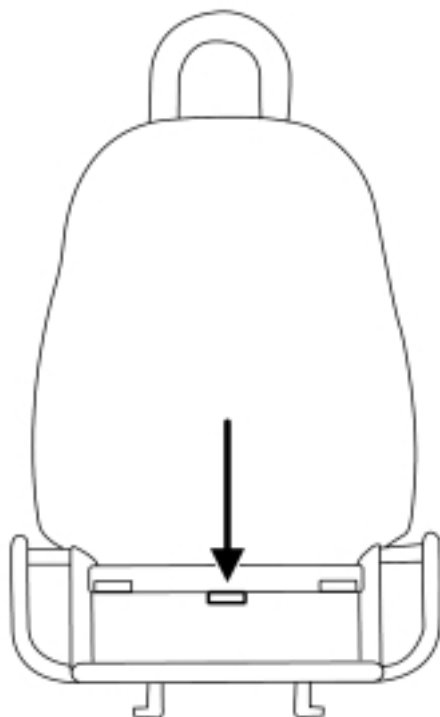

4. Clip the tether strap to the anchor as shown.



If the tether strap is clipped incorrectly, the child safety seat may not be retained properly in the event of a collision.

5. Refer to the *Installing child safety seats in combination lap and shoulder belt seating positions* section of this chapter for further instructions to secure the child safety seat.

6. Tighten the child safety seat tether strap according to the manufacturer's instructions.

Seating and safety restraints



If the safety seat is not anchored properly, the risk of a child being injured in a collision greatly increases.

Attaching safety seats with LATCH (Lower Anchors and Tethers for Children) attachments for child seat anchors

Some child safety seats have two rigid or webbing mounted attachments that connect to two anchors at a certain seating position in your vehicle. This type of child seat eliminates the need to use safety belts to attach the child seat. For forward-facing child seats, the tether strap must also be attached to the proper tether anchor. See *Attaching safety seats with tether straps* in this chapter.

Your vehicle has LATCH anchors for child seat installation at the optional LATCH equipped front passenger seat.

The lower anchors for child seat installation are located at the rear section of the optional LATCH equipped front passenger seat between the cushion and seat back.

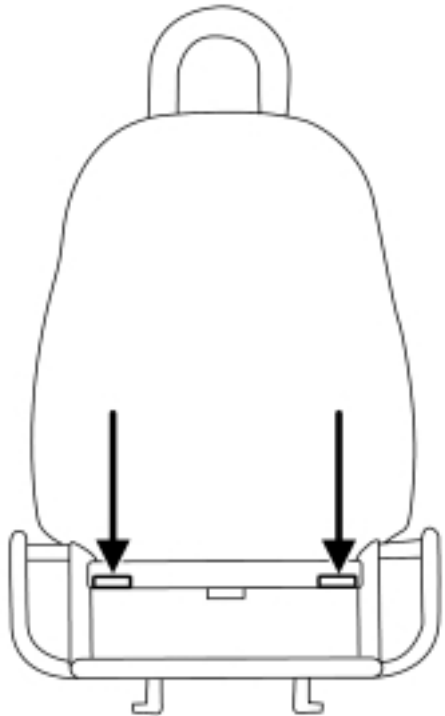

Seating and safety restraints

Follow the child seat manufacturer's instructions to properly install a child seat with LATCH attachments. Two plastic LATCH guides can be obtained at no charge from any TH!NK dealer. They snap onto the LATCH lower anchors in the seat to help attach a child seat with rigid attachments. The guides hold the seat trim away to expose the anchor and make it easier to attach some child seats.



Attach LATCH lower attachments of the child seat only to the anchors shown.

If you install a child seat with rigid LATCH attachments, do not tighten the tether strap enough to lift the child seat off the vehicle seat cushion when the child is seated in it. Keep the tether strap just snug without lifting the front of the child seat. Keeping the child seat just touching the vehicle seat gives the best protection in a severe crash.

Each time you use the safety seat, check that the seat is properly attached to the lower anchors and tether anchor. Try to tilt the child seat from side to side. Also try to tug the seat forward. Check to see if the anchors hold the seat in place.



If the safety seat is not anchored properly, the risk of a child being injured in a crash greatly increases.

Driving

STARTING

Operating positions

The drive mode selector switch serves two functions. It powers up the electric motor by activating the battery pack to connect the power to the drivetrain



system. It also functions as a gear selector by placing the drive mode selector switch key in one of four modes: R (Reverse), ● (OFF), T (Turf), and D (Drive).



Never press the accelerator while turning the drive mode selector switch key from ● (OFF) to one of the driving modes. Always firmly apply the brake pedal until ready to drive the vehicle in the selected mode. In addition, follow the safety steps in *Important safety precautions* in this chapter.

1. R (Reverse mode)

The R (Reverse) mode is used to maneuver your vehicle out of parking spots or rough terrain where you cannot proceed forward. A reverse warning will sound to alarm the driver that the vehicle will be backing up. The maximum speed in R (Reverse) is 13 km/h (8 mph).



Extra care should be used to visually check behind the vehicle before engaging R (Reverse) mode. Do not rely on your mirrors alone as there may be blind spots, depending on how you have the mirrors adjusted.

2. ● (OFF)

The ● (OFF) position for the drive mode selector switch key will power down the drivetrain system as well as the other vehicle systems. The parking brake should always be engaged when the key is in this position.

3. T (Turf) mode

The T (Turf) mode is used when you are driving on grass, sand, dirt, gravel, or pathways with loose surfaces to provide safe handling characteristics of your vehicle. The maximum speed in T (Turf) mode is 24 km/h (15 mph).

4. D (Drive) mode

The D (Drive) mode will provide maximum performance from your vehicle on the paved paths and paved roadways. Your vehicle's maximum speed is 25 mph (40 km/h) and you should only operate your vehicle on roadways with a maximum speed of 56 km/h (35 mph) or less.

Park brake reminder

The park brake reminder is a tone that sounds for 10 seconds when the drive mode selector switch is turned to the OFF position with the parking brake not set. It will cease to sound after 10 seconds or when the parking brake is engaged. During this time the vehicle is “alive” with functional park brake reminder and the gauge will be active and backlit. After 10 seconds, the vehicle shuts down and the park brake reminder is no longer functional.



To avoid serious injury, death, and/or property damage, always engage the parking brake before leaving the vehicle.

Driving

Important safety precautions

Before operating the vehicle:

1. Make sure all vehicle occupants have buckled their safety belt. For more information on safety belts and their proper usage, refer to *Seating and safety restraints*.

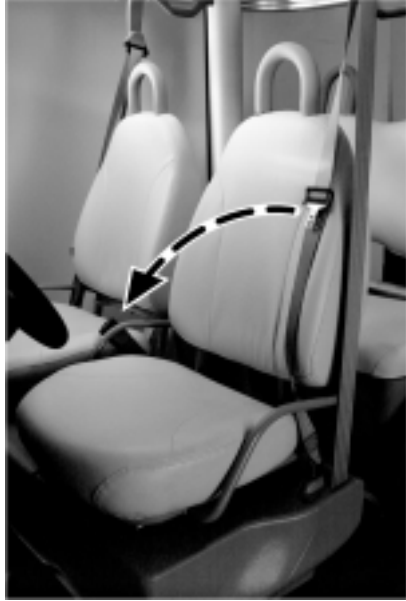

Do not drive the vehicle with the weather enclosure side panels fully unzipped. They will drag on the ground damaging the panels.

Any stowed panels should not contact the tires or ground to prevent damage to the panels.

2. If equipped, make sure the weather enclosure side panels are not fully unzipped or, if stowed, do not contact the ground or tires.

3. Make sure all accessories, such as headlamps, are turned off.



4. Make sure the parking brake is set.



5. Do not press the accelerator while turning the drive mode selector key. Always firmly apply the brake pedal until you are ready to drive the vehicle in the selected mode.

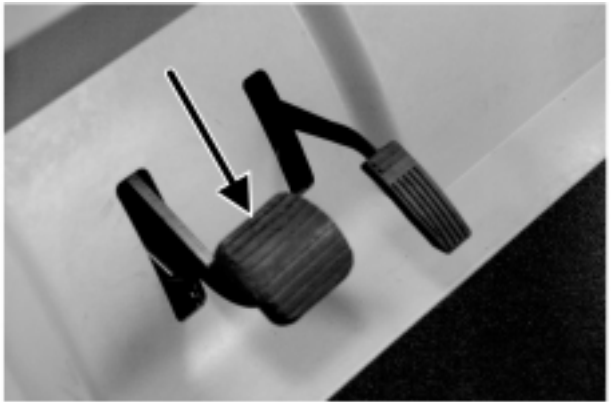

To operate the vehicle:

1. Insert the key in the drive mode selector switch.
2. Depress the brake pedal.

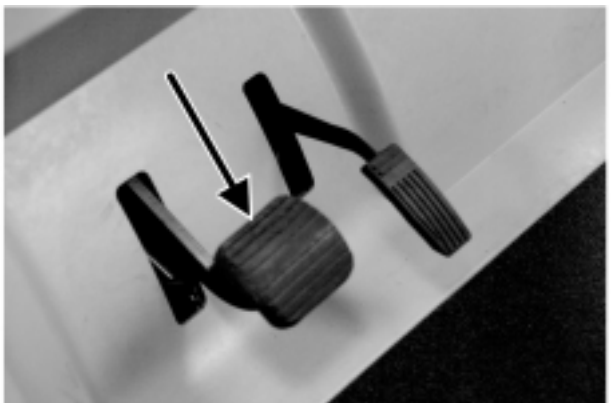

3. Turn the drive mode selector key to the desired operating mode.
4. Release the brake pedal.

Driving

5. Gradually depress the accelerator pedal.

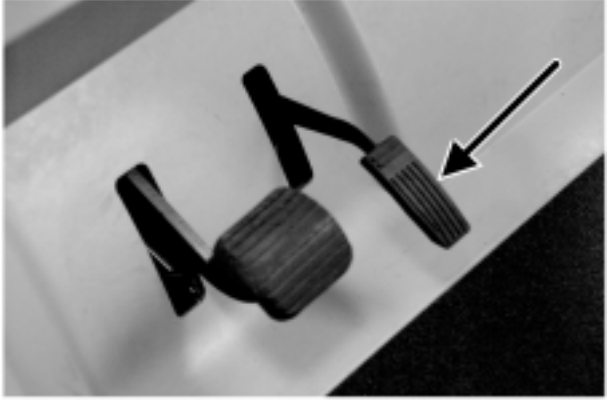

When parking the vehicle and turning it off:

1. Make sure the parking brake is set.



2. Turn the drive mode selector switch to ● (OFF) and remove the key from the mode select switch to prevent unauthorized use.



3. Store any items in the locking glove box and locking rear storage compartment.



4. Whenever possible, recharge your vehicle batteries to maximize your range and battery life.

Energy tips

The range the vehicle can travel is affected by:

- The use of vehicle accessories
- Driving habits
- Type of tire (Turf tires reduce vehicle range)
- Weather conditions
- Age of battery pack
- Climbing steep terrain
- Driving off-road

To maximize the vehicle's range, follow these steps:

- Keep the tires properly inflated.
- Keep payloads as light as possible.
- Avoid frequent full throttle usage.
- Maintain a steady speed while driving.
- Cruise at moderate speeds.
- Select routes that minimize the number of starts and stops encountered.
- Charge the vehicle after every use.

Driving

BRAKES

Parking brake

Apply the parking brake whenever the vehicle is parked or left unattended. To set the parking brake, pull up on the lever between the front seats as far as it will go. The brake status indicator will be illuminated whenever the parking brake is engaged and the drive mode selector switch is turned to one of the run modes.



To release the parking brake, pull up on the handle, push the button in on the end of the handle, and lower the handle to the horizontal position. The brake status indicator will turn off when the parking brake is fully released and the drive mode selector switch is turned to one of the run modes.

The parking brake is not recommended to stop a moving vehicle. However if the normal brakes fail, the parking brake can be used to stop the vehicle in an emergency situation. Since the parking brake only applies the rear brakes, the vehicle's stopping distance will greatly increase.

Park brake reminder

The park brake reminder is a tone that sounds for ten seconds when the drive mode selector switch is turned to the OFF position with the parking brake not set. It will cease to sound after ten seconds or when the parking brake is engaged.

During this time the vehicle is “alive” with functional park brake reminder and the gauge will be active and backlit. After the ten seconds the vehicle shuts down and park brake reminder is no longer functional.



To avoid serious injury, death, and/or property damage, always engage the parking brake before leaving the vehicle.

Dual circuit braking system

The hydraulic brake system is a dual circuit design. This means if you have a brake system fluid leak or failure, half of your brake system may remain operational; the system will stop your vehicle, but your stopping distance will be greatly increased.

Regenerative Braking System (RBS)

Another feature of your vehicle is the Regenerative Braking System (RBS). The RBS is designed to utilize the vehicle’s forward motion to generate electricity and partially recharge the batteries for a nominal increase in driving range. The RBS works when you are not applying the accelerator. Once the accelerator pedal is released, the vehicle automatically and slowly decelerates. This deceleration is caused by using the spinning motor as a generator to create electrical current. This recharges the battery pack and slows the vehicle. The RBS works only when the vehicle is traveling at 29 km/h (18 mph) or greater and the batteries are at less than 80% state of charge. When driving down hills, regenerative braking may be used to maintain speed while recovering energy similar to the way

Driving

engine braking is typically used. When the battery is fully charged, regenerative braking is eliminated to prevent overcharging of the batteries. Regenerative braking does not take the place of the standard friction brakes; it only assists them.

Caution: If the battery pack is fully charged, RBS will not be enabled because the battery pack cannot accept the additional current. The contactor is designed to open if the battery pack voltage exceeds 80V. Avoid driving situations where you will be driving down steep grades with a fully charged battery pack or the drive system and RBS will shut down. The standard braking system is not affected but speeds may exceed 25 mph (40 km/h). If this should occur, apply brakes to reduce and maintain speeds below 25 mph (40 km/h).

Charging

BATTERY CHARGING

Battery charging uses 120 volt AC 15A service. The GFCI (ground fault circuit interrupt) charge cord supplied with your vehicle plugs directly into the charge inlet located below and to the left of the steering wheel. Approximately 8-10 hours are needed to replenish a 20% (one bar showing) charged battery pack. Charge the vehicle whenever the state of charge is less than 80% (four bars showing) to maximize your travel range and prolong the battery life.

The battery charger receives 120 volt AC 15A power from an external standard grounded 3-prong outlet and converts it to DC energy. The battery charger only operates when a GFCI charger cord is plugged into your vehicle. If the battery charger detects any presence of AC current, your vehicle cannot be started or driven.

Caution: If you allow your vehicle to sit in conditions of -6°C (20°F) or less with a state of charge of 20% (one bar showing on gauge) or less, the batteries could freeze. Allowing the batteries to freeze may cause permanent damage to the batteries and permanently reduce their capacity. In cold conditions, place the vehicle in an area greater than 0°C (32°F) and allow it to warm up before charging. Never charge the vehicle if the batteries may be frozen. Allow the batteries to warm above 0°C (32°F) first, then charge.



There are gases around the batteries that can explode if exposed to flames, sparks, or lit cigarettes. The amount of gas is increased during battery charging. An explosion could result in personal injury or vehicle damage.



Do not charge the batteries with the weather enclosure closed or the vehicle cover in place. A build up of hydrogen gas can result which can explode. The charging area should be well ventilated.

Charging

Caution: Do not allow the vehicle to remain in a discharged state, as batteries may be permanently damaged and vehicle range will be decreased.

To recharge your vehicle batteries:

Use only the GFCI cord supplied with the vehicle. If the GFCI cord does not fit the receptacle, have a qualified electrician install the proper outlet.

Note: The outlet must be properly installed and grounded in accordance with all local codes and ordinances.

1. Park your vehicle within GFCI charger cord length of a 120 volt AC 15A grounded 3-prong wall outlet.
2. Place the drive mode selector switch in the OFF position, remove the key and set the parking brake.

Note: Make sure the power point (if equipped) is not in use.

Note: Make sure that the inlet is clean and dry.

Note: Never use a plug adapter or an extension cord.

3. Insert the male end of the GFCI charger cord in a 120 volt AC grounded receptacle. Verify that the power indicator light on the GFCI cord is on.

4. Open the charge inlet access door.



Charging

5. Align the GFCI charger cord with the charge inlet and fully insert the plug into the outlet.



6. Verify that the battery charge indicator on the instrument cluster is illuminated during the charging process.

Note: The humming noise you will hear is the transformer on the charger, which will operate regardless of whether the vehicle is accepting the charge.

Note: If the charge indicator fails to display, make sure the service disconnect switch is in the ON position. If the service disconnect switch is on while charging and the charge indicator fails to display, follow the flow chart on the next page.

Charging

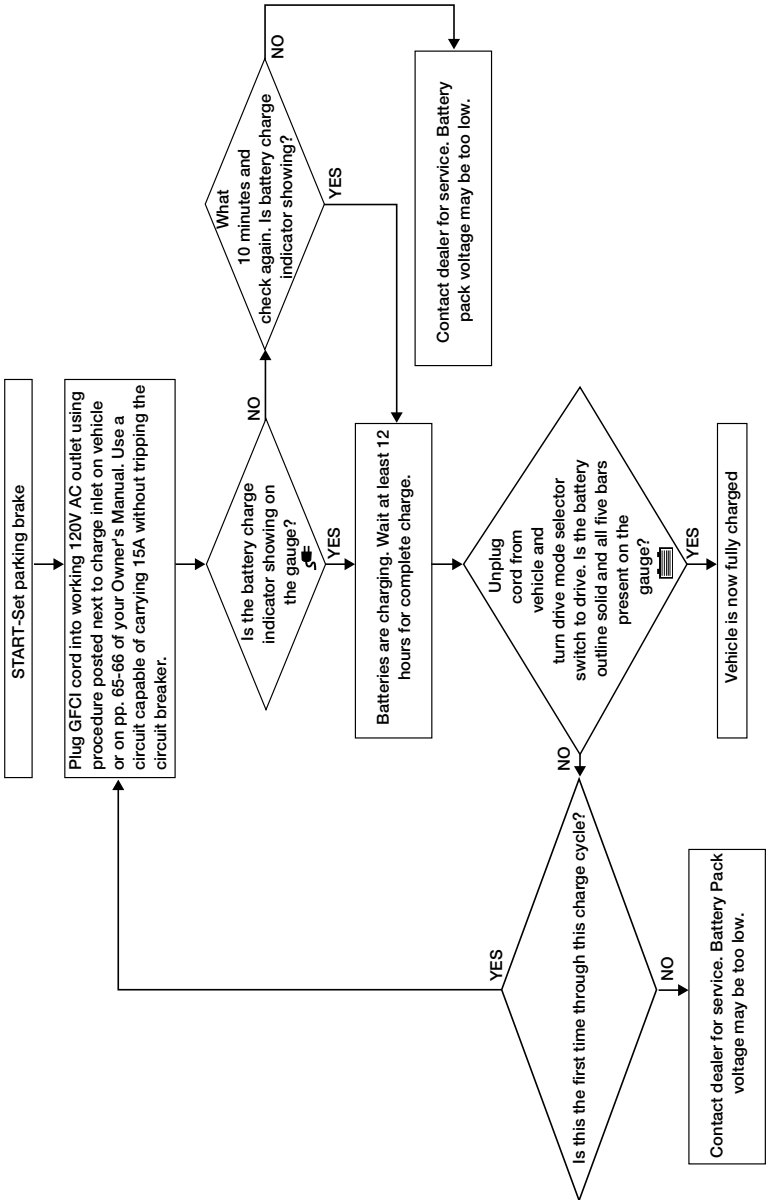

After properly connecting the vehicle to the receptacle, the charger will initiate a four stage charging process. In the first stage, the battery is tested. Further charging is prohibited if the charger discovers a fault. If the battery passes, the charger determines the appropriate charging rate, depending upon the voltage of the battery pack, and charges the battery pack. In the second and third stages, the voltage is regulated, and charging is completed. The battery is maintained at the full state of charge in the fourth stage. If the vehicle is left on, the charger

Charging

will automatically reinitiate a new charge cycle every 28 days.

To stop charging of your vehicle batteries:

1. Push the TEST button on your GFCI charger cord. Verify that the indicator light on the GFCI is OFF.



2. Disconnect the GFCI charger cord from the wall outlet.

3. Disconnect the GFCI charger cord from the charge inlet.

4. Store the cord in a safe and dry location.

BATTERY CHARGING DURING VEHICLE STORAGE

The seat stanchion front cover should be removed to access the service disconnect switch. The service disconnect switch is

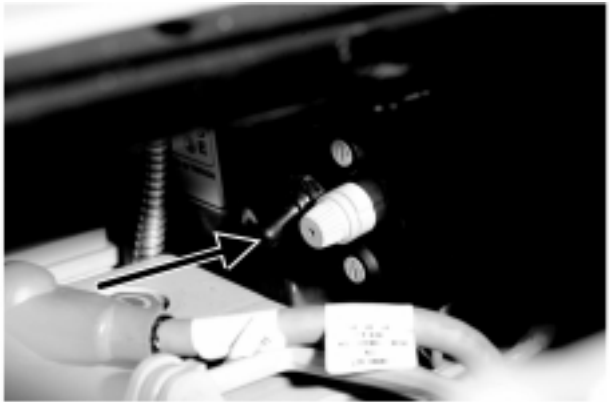

located below and behind the parking brake lever within the seat stanchion (battery cover). It is a black rubber switch and faces the front of the the vehicle. It is not encouraged to blindly reach down through the driver's side opening on top of the seat stanchion cover when the cushion is removed.

Charging

The vehicle can be stored for 14 days with the service disconnect switch on. This assumes a full charge when stored. If this time is exceeded or the batteries were not fully charged prior to storing the vehicle, the batteries may be severely discharged resulting in permanent damage. This will reduce the capacity of the batteries and vehicle range. As batteries age, the amount of time the vehicle can be stored without turning the service disconnect switch off will decrease.

The vehicle can be stored with the service disconnect switch off for six months if starting with a full charge; however, the vehicle should be charged monthly if possible. With the service disconnect switch in the OFF position, there is a minimal draw from the vehicle components. The battery self-discharge determines the storage time. This is less than 5% per month at temperatures between 4°C and 21°C (40°F and 70°F). Self-discharge increases slightly at higher temperatures. If the batteries are nearly discharged, they may freeze at 0°C (32°F) or below. This will cause severe damage that may even cause leakage of the electrolyte.

Roadside emergencies

HAZARD FLASHER SWITCH

Use the hazard flashers only in an emergency to warn traffic of your vehicle breakdown, or approaching danger, etc. The hazard flashers can be operated with the drive



mode selector switch in all positions. The hazard flasher switch is located on top of the steering column, right behind the steering wheel. Depress the switch to activate the hazard lights. To turn off the hazard lights, depress the switch again.

With the hazard flasher switch depressed, both



turn signal indicators will flash on the instrument panel cluster.

12V FUSES

Change a fuse

If electrical components are not working, check the circuit fuse first to see if it is blown. You can identify a blown fuse

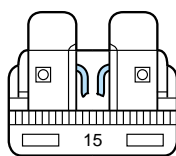

by the broken wire in the center of the fuse between two prongs.



Always replace a fuse with one that has the specified amperage rating. Using a fuse with a higher amperage rating can cause severe wire damage and could start a fire.

Roadside emergencies

Central fuses

To access the fuses:

1. Unlock and remove the hood.



2. Inspect the fuse for the circuit with a malfunction and replace the fuse if necessary.

Always use the same amperage rated fuse as a replacement.

See the chart

for the fuse amperage ratings and circuit descriptions.

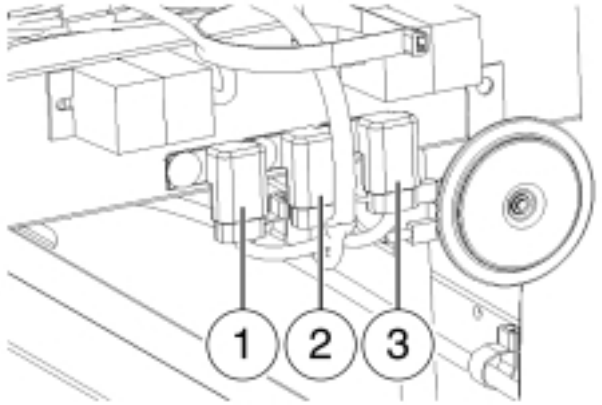

Fuse Location	Fuse Amp Rating	Fuse color	Circuit description
1	20A	Blue	Horn, Flasher, Brake
2	20A	Blue	Lights
3	10A	Red	Wiper, Washer, Gauge

3. After replacing the fuse, check the component to verify that it is operating properly.

4. Install and lock the hood.

Roadside emergencies

Power point fuse (if equipped)

The power point (if equipped) requires a 20A fuse.



CHANGING THE TIRES

Your vehicle is not equipped with a spare tire. Should your tires require service take you vehicle to an authorized Dealer.

Jacking

Lifting instructions

Damage to the suspension or steering linkage system components may occur when positioning the jack pad. The pad should be positioned carefully to ensure maximum contact under the frame.

When lifting a vehicle, care should be taken to position the vehicle so that the jack pads do not damage the halfshafts, steering linkage or suspension arms. Damage to suspension and/or steering linkage components may occur.

To lessen risk of personal injury, do not put any part of your body under the vehicle while jacking.

Roadside emergencies

Your vehicle is constructed with many aluminum components which may be damaged if:



- The proper jack lifting points are not utilized.

Roadside emergencies



- A bottle type jack is used for ANY lifting of the vehicle.
- The jack is not secured on a level and solid surface.

WRECKER TOWING

If you need to have your vehicle towed, contact a professional towing service or, if you are a member, your roadside assistance center.

It is recommended that your vehicle be towed with flatbed equipment. Do not tow with a slingbelt. TH!NK Mobility has not approved a slingbelt towing procedure.

It is not acceptable to tow the vehicle with the front wheels on the ground (without dollies) and the rear wheels off the ground.

If the vehicle is towed by other means or incorrectly, vehicle damage may occur.

Roadside emergencies

If your vehicle must be towed using another low speed vehicle, for example in the event the batteries are discharged, the service disconnect



switch should be switched to the OFF position.

The seat stanchion front cover should be removed to access the service disconnect switch. The service disconnect switch is located below and behind the parking brake lever within the seat stanchion (battery cover). It is a black rubber switch and faces the front of the the vehicle. It is not encouraged to blindly reach down through the driver's side opening on top of the seat stanchion cover when the cushion is removed. It is not encouraged to blindly reach down through the driver's side opening on top of the seat stanchion cover when the cushion is removed.

Each corner of your vehicle is equipped with a tow/tie down hook. Both front or both rear tow hooks *must* be used for towing or recovery operations.



Additionally, when shipping or transporting, all four tow/tie down hooks *must* be used to prevent damage.

WASHING YOUR VEHICLE

Do not take your vehicle to an automatic car wash or use a high power spray hose to wash your vehicle.

Wash your vehicle regularly with cold or lukewarm water. Never use strong detergents or soaps. Always use a clean sponge and plenty of water to avoid scratching the dirt into your vehicle's finish. To avoid spotting, do not wash your vehicle in direct sunlight.

Any chemicals or foreign material such as tar, tree sap, industrial fallout, and bird droppings should be cleaned off your vehicle as soon as possible.

When adding brake fluid to the brake reservoir, avoid spilling fluid onto the vehicle's plastic panels, including the instrument panel. If brake fluid is spilled on any surface, wash it immediately with soap and water to prevent cracking, discoloration, or other damage.

The windshield and mirrors can be cleaned using a household commercial glass cleaner and soft, lint-free cloth.

UNDERBODY

Flush the complete underside of the vehicle regularly. Inspect for damage.

WAXING YOUR VEHICLE

Waxing your vehicle on a regular basis will reduce minor scratches and surface damage.

Wax the vehicle when water stops beading on the surface. This could be every three or four months, depending on operation.

Use Meguiars polish #8232 found at local auto parts stores. Use a cleaning fluid with a clean cloth to remove any foreign material, such as dirt or insects, before waxing your vehicle. Use tar remover to remove any tar spots.

Cleaning

REPAIRING SCRATCHES

The specific process that is used to remove minor scratches should be performed by an authorized Dealer.

CLEANING WHEELS

Wash with the same detergent used to wash the body of the vehicle. Do not use acid-based or alcohol-based wheel cleaners, steel wool, fuel or strong detergents. Never use abrasives that will damage the finish of special wheel surfaces. Use a tar remover to remove grease and tar.

CLEANING EXTERIOR LAMPS

Wash with the same detergent used to wash the vehicle exterior. If necessary, use a tar remover, such as Ford Extra Strength Tar and Road Oil Remover (B7A-19520-AA).

To avoid scratching the lamps, do not use a dry paper towel, chemical solvents or abrasive cleaners.

CLEANING THE INSTRUMENT PANEL

Clean the instrument panel with a damp cloth, then dry it with a dry cloth.

CLEANING THE GAUGE ASSEMBLY

Clean the gauge assembly with a damp cloth, then dry it with a dry cloth.

CLEANING AND MAINTAINING THE SAFETY BELTS

Clean the safety belts with a mild soap solution of the type recommended for cleaning upholstery or carpets.

Do not use bleach, dye or any other solvent to clean the belts, as these actions may weaken the belt webbing.

Check the safety belt system periodically to make sure there are no nicks, tears, or cuts. If the vehicle has been involved in an accident, refer to the *Seating and safety restraints* chapter.

CLEANING THE INTERIOR

Remove dust and loose dirt with a whisk broom or a vacuum cleaner. Remove fresh spots immediately. Do not use household or glass cleaners. These agents can stain and discolor the fabric. Use a mild soap and water solution, if necessary.

CLEANING THE WEATHER ENCLOSURE

Rinse any surface dirt off before cleaning the weather enclosure. Use a mild soapy cool/warm water solution and a clean soft cloth to clean the clear plastic window sections of the weather enclosure. Use plenty of water to keep the clear plastic wet. **DO NOT** use a strong detergent, bleach, or any abrasive cleaners to clean any part of the weather enclosure.

To clean the colored vinyl portions of the weather enclosure, use a mild soapy cool/warm water solution and a soft brush, sponge, or cloth. Rinse the weather enclosure thoroughly and air dry completely before using or storing it. **DO NOT USE** heat guns, or hair dryers. **DO NOT** put the weather enclosure into a washing machine or dryer of any kind. **DO NOT IRON.**

Maintenance and specifications

BATTERIES

Flooded batteries must be refilled with distilled or demineralized water to avoid internal damage.

For longer, trouble-free operation, keep the top of the batteries clean and dry. Also, make certain the battery cables are always tightly fastened to the battery terminals. The battery terminals require a specific torque setting, so if any cable appears to be loose, contact your TH!NK dealer for service.

If you see any corrosion on the batteries or terminals, push the rubber boots back and clean the terminals with a wire toothbrush. You can neutralize the acid with a solution of baking soda and water.

Caution: If you allow your vehicle to sit in conditions of -6°C (20°F) or less with a state of charge of 20% (one bar showing on gauge) or less, the batteries could freeze. Allowing the batteries to freeze may cause permanent damage to the batteries and permanently reduce their capacity. In cold conditions, place the vehicle in an area greater than 0°C (32°F) and allow it to warm up before charging. Never charge the vehicle if the batteries may be frozen. Allow the batteries to warm above 0°C (32°F) first, then charge.

Caution: Do not park and leave the vehicle with discharged batteries. The batteries could discharge to the point where damage could occur and the battery charger will not charge. The vehicle will have to be taken to an authorized TH!NK dealer if this happens.



Batteries normally produce explosive gases which can cause personal injury. Therefore, do not allow flames, sparks or lighted substances to come near the battery. When working near the battery, always shield your face and protect your eyes. Always provide proper ventilation.

Maintenance and specifications



When lifting a plastic-cased battery, excessive pressure on the end walls could cause acid to flow through the vent caps, resulting in personal injury and/or damage to the vehicle or battery. Lift the battery with a battery carrier or with your hands on opposite corners. Do not lift a battery by the terminal posts, or internal damage may result.



Keep batteries out of reach of children. Batteries contain sulfuric acid. Avoid contact with skin, eyes or clothing. Shield your eyes when working near the battery to protect against possible splashing of acid solution. In case of acid contact with skin or eyes, flush immediately with water for a minimum of 15 minutes and get prompt medical attention. If acid is swallowed, call a physician immediately.

- Always dispose of automotive batteries in a responsible manner. Follow your local authorized standards for disposal. Call

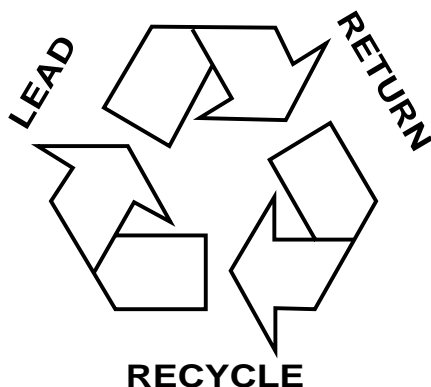

your local authorized recycling center to find out more about recycling automotive batteries.



Remove all jewelry, rings, bracelets, and chains that may come into contact with the battery terminals or wiring.



Battery posts, terminals and related accessories contain lead and lead compounds. **Wash hands after handling.**

Maintenance and specifications

Flooded type batteries

If your vehicle is equipped with “flooded” batteries, the battery cells need to be checked and have distilled or demineralized water added as required. The batteries in your vehicle are located under the front seats. They are 12 volt, 6 cell batteries.

The battery water reminder indicator in the instrument cluster will illuminate to remind you to check the water level in the batteries. Perform this maintenance in a well-ventilated area that is dry and well lit.

To check the water level in your batteries:

1. Pull straight up on the front of the front seat cushions to release the clips.



2. Remove the two center push pins.

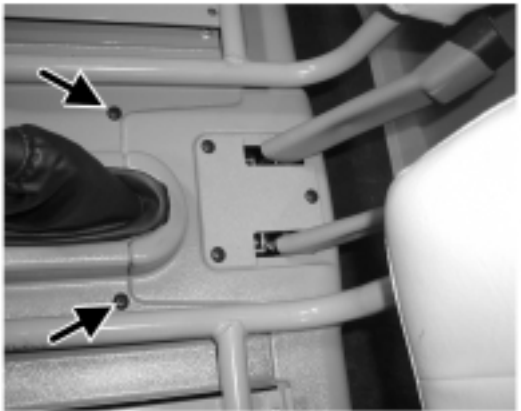

Maintenance and specifications

3. From both sides of the vehicle, remove the two push pins. (Driver side shown; passenger side similar)

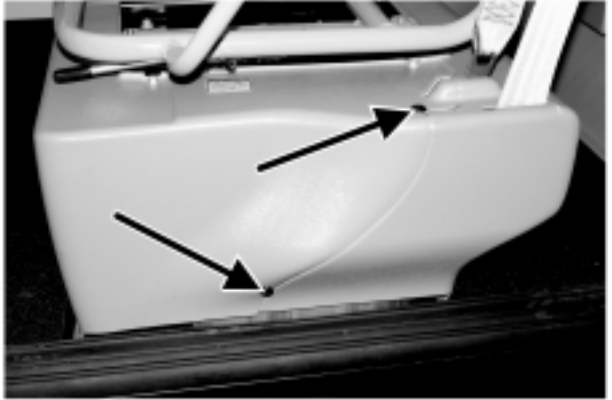

4. From both sides of the vehicle, remove four bolts from beside the seat frame. (Driver side shown; passenger side is similar.)

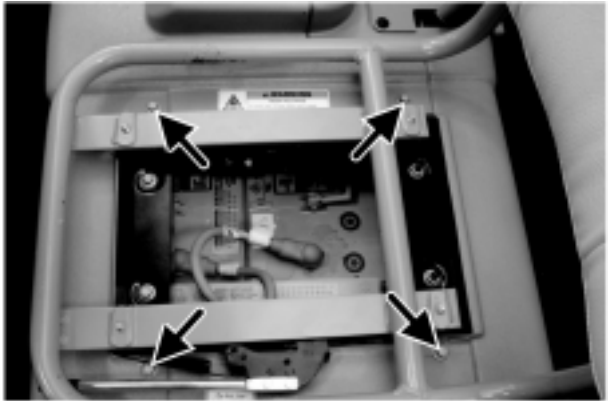

Do not touch the battery terminals with your hands or a metal object. Also, do not lay any tools on the batteries and never connect one battery terminal with another with any tool or metal object laid across the top of the battery.



This vehicle contains a high voltage electrical system. Serious injury, death, and/or property damage may result if this vehicle is not properly used, charged or serviced as stated in this manual. Read this owner's guide prior to use, charging, or servicing this vehicle. Do not drill, cut, or modify any part of this vehicle, as high voltage wiring is present. Do not use jumper cables. Only charge this vehicle with an approved GFCI cord as stated in Battery charging.

Maintenance and specifications

5. Inside each cell opening is a slotted cup protruding down into the battery cell. If battery fluid is visible in the slotted cup, reinstall the cap. If no fluid is visible in the slotted cup in the battery cell, carefully add demineralized water or distilled water until the battery fluid level reaches 1/8" from the bottom of the slotted cup. Do not overfill.

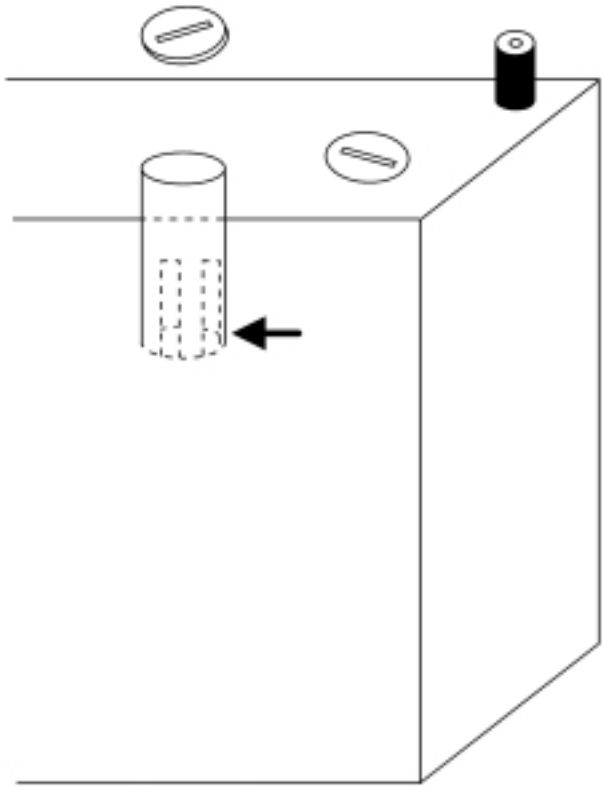

6. When you have completed adding water, make sure each battery cell cap is securely installed. Wipe any spilled water off the top of the battery.

7. Reinstall the body component(s) in reverse order of removal and tighten the bolts securely.

Maintenance-free type batteries

If your vehicle is equipped with maintenance-free batteries, it does not require additional water during its life of service. Removing the caps could void the battery warranty.

BRAKE FLUID

The brake fluid switch will illuminate the brake icon on the gauge if the brake fluid falls below a safe level.

Maintenance and specifications

When adding brake fluid to the brake reservoir, avoid spilling fluid onto the vehicle's plastic panels, including the instrument panel. If brake fluid is spilled on any surface, wash it immediately with soap and water to prevent cracking, discoloration, or other damage.

To check and add brake fluid:

1. Remove the scrivet and remove the driver side storage tray.



2. Inspect the brake fluid level at the side of the reservoir.

3. Remove the brake reservoir cap to add brake fluid as necessary.

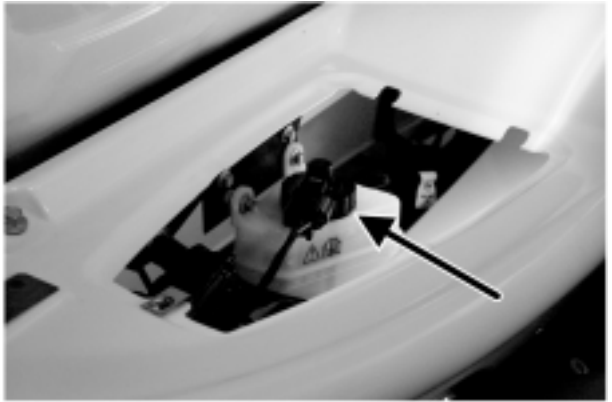

Always use High Performance Dot 3 brake fluid. Use of other non-Dot 3 fluid could result in loss of brakes.

4. Reinstall the brake reservoir cap. Wipe off any excess brake fluid.
5. Reinstall the driver side storage tray and tighten the scrivet securely.

Maintenance and specifications

SERVICING YOUR TIRES

Checking the tire pressure

- Use an accurate tire pressure gauge.
- Check the tire pressure when tires are cold, after the vehicle has been parked for at least one hour or has been driven less than 5 km (3 miles).
- Adjust tire pressure to recommended specifications found on the Certification Label located on the roof panel towards the rear of the vehicle.



Improperly inflated tires can affect vehicle handling and can fail suddenly, possibly resulting in loss of vehicle control.

Tire rotation

Because your vehicle's tires perform different jobs, they often wear differently. To make sure your tires wear evenly and last longer, rotate them as indicated in the scheduled maintenance guide. If you notice that the tires wear unevenly, have them checked.

- Four tire rotation

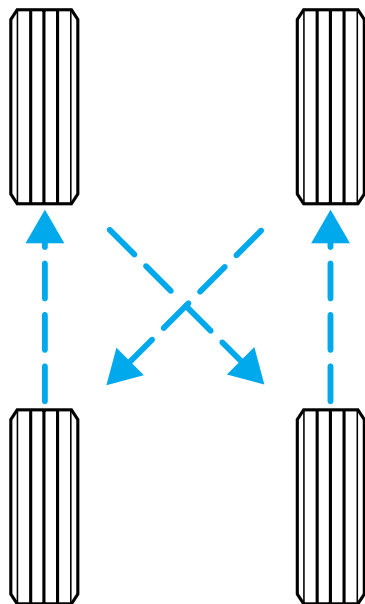

Maintenance and specifications

Replacing the tires

Replace the tires when the wear band is visible through the tire treads.

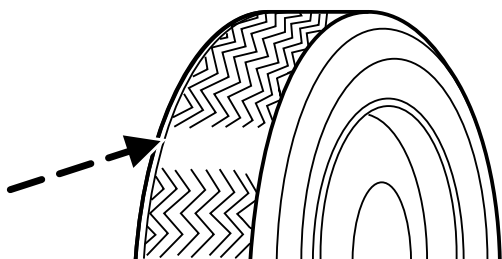

Your TH!NK neighbor is equipped with either standard street or turf tires. The load rating for these tires is 470 kg (1036 lbs). These tires also comply with the requirements of Federal motor vehicle safety standards (FMVSS) 109 and FMVSS 119, and carry a “DOT” marking, indicating they may be used for highway service. TH!NK recommends that any replacement tires you purchase carry the DOT marking, showing they are approved for highway service. DO NOT replace with non-OE tires designated “NHS” (Not for Highway Service). OE tires are available through your TH!NK dealer.

Tires that are larger or smaller than your vehicle’s original tires may also affect the accuracy of your speedometer.

PART NUMBERS

Component	Part number
Battery (standard)	10655-AA
Battery (optional)	10655-BA
Tire (Street tire)	1531-AA
Tire (Turf tire)	1531-BA
Windshield wiper blade	17528-AA

Maintenance and specifications

REFILL CAPACITIES

Fluid	Ford Part Name	Application	Capacity
Brake fluid	Motorcraft High Performance DOT 3 Motor Vehicle Brake Fluid	All	Fill to line on reservoir
Gearbox	80W90	All	.69 quarts (.65 Liters)

LUBRICANT SPECIFICATIONS

Items	Ford Part Name or equivalent	Ford Part Number	Ford Specification
Battery terminal lubricant	Electrical grease	F8AZ-19G208-AA	WSB-M1C239-A
Brake fluid	Motorcraft High Performance DOT 3 Motor Vehicle Brake Fluid	C6AZ-19542-AB	ESA-M6C25-A and DOT 3
Seat tracks	Multi-Purpose Grease	DOAZ-19584-AA or F5AZ-19G209-AA	ESA-M1C93-B or ESR-M1C159-A
Lock cylinders	Penetrating and Lock Lubricant	Motorcraft XL-1	None
Gearbox	80W90 Premium Rear Axle Lubricant	XY-80W90-QL	WSP-M2C197-A
Half shaft splines	CV Joint Grease (High Temp.)	E43Z-19590-A	ESP-M1C207-A
Windshield washer fluid	Ultra-clear Windshield Washer Concentrate	ZC-18-A or ZC-18-B	ESR-M17P5-A

Maintenance and specifications

PERIODIC SERVICE SCHEDULE

Regular Interval	Item	Service
Daily service by owner	Batteries	Charge batteries (as often as possible).
Monthly service by owner or qualified technician	Batteries	Check electrolyte level. Add distilled water or demineralized water as necessary per maintenance and service manual.
		Wash battery tops and clean terminals with baking soda/water solution. Dispose of waste water properly.
	Tires	Check air pressure and adjust as necessary.
	General vehicle	Wash battery compartment and underside of vehicle. Dispose of waste water properly.
Semi-annual service by a qualified technician only	Brake system	Check brake shoes (replace if necessary).
		Brake linkage and pivots
		Lubricate brake slides.
		Check brake cables for damage; replace as required.
	Electrical wiring and connections	Check for tightness and damage.
	Front wheel alignment	Check and adjust as required.

Maintenance and specifications

Regular Interval	Item	Service
Annual service by qualified technician	Batteries	Perform battery tests per maintenance and service manual.
		Check for proper battery terminal tightness.
		Inspect the brake pushrod locknut for tightness.
		Check/fill gearbox fluid to the amount indicated in refill capacities chart.
		Inspect front wheel bearings (repack as necessary).
16093 kilometers (10,000 miles)	Tires	Rotate the tires

VEHICLE DIMENSIONS

Vehicle dimensions	2 passenger mm (in)	4 passenger mm (in)
(1) Overall length	2, 642 (104)	2, 898 (114.1)
(2) Overall width	1, 433 (56.4)	1, 433 (56.4)
(3) Overall height	1, 720 (67.7)	1, 720 (67.7)
(4) Wheelbase	1, 726 (67.9)	1, 980 (77.9)
(5) Track - Street tires	1274 (50.1)	1274 (50.1)
(5) Track - Turf tires	1234 (48.6)	1234 (48.6)

Maintenance and specifications

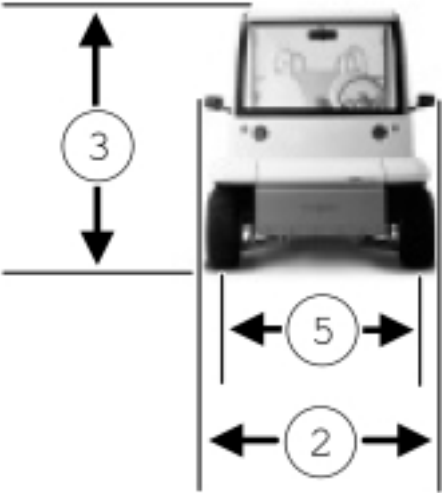
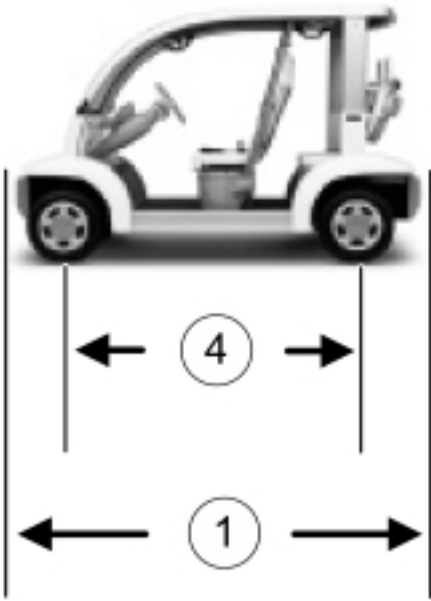

Maintenance and specifications

IDENTIFYING YOUR VEHICLE

Certification label (typical label shown)

The National Highway Traffic Safety Administration Regulations require that a Certification label be affixed to a vehicle and prescribe where the Certification label may be located. The Certification label is located on roof panel towards the rear of the vehicle.

MFD. BY FORD MOTOR CO. IN U.S.A.							
DATE: XXXXX	GVWR: XXXXX LB/ XXXXX KG						
FGAWR: XXXXXX/XXXXXXXX	RGAWR: XXXXXX/XXXXXXXX						
THIS VEHICLE CONFORMS TO ALL APPLICABLE FEDERAL MOTOR VEHICLE SAFETY STANDARDS IN EFFECT ON THE DATE OF MANUFACTURE SHOWN ABOVE.							
VIN: XXXXXXXXXXXXXXXXX				TYPE: XXXXXXXXXXXXXXXXX			
							
MAXIMUM LOAD=OCCUPANTS + LUGGAGE=XXXKG/XXXLB							
OCCUPANTS: X TOTAL X FR X 2ND X RR OCCUPANTS LUGGAGE XX XXXKG/XXXLB							
TIRE: XXXX/XXXXX XXX				X XXXKG/XXXLB			
PRESSURE (FR) XXX kPa/ XX PSI COLD							
PRESSURE (RR) XXX kPa/ XX PSI COLD							
TRAILER TOWING - SEE OWNER GUIDE							
EXT PNT: XXXXXX XXXXXX		RC: XX		DSO: XXXX		F0000	
BAR INT TR TP/PS R		AXLE TR SPR		T0000			
X XX XXX X		XX X XXX					
UTC VFOHT-15294A10-GA							

Vehicle identification number

The vehicle identification number is on a metal tag located on the driver side instrument panel.



Customer assistance

In order to help you service your TH!NK neighbor, please have the following information available when contacting a Customer Relationship Center:

- Your telephone number (home and business).
- The name of the dealer and the city where the dealership is located.
- The year and make of your vehicle.
- The date of vehicle purchase.
- The current odometer reading.
- The vehicle identification number (VIN).

If you still have a complaint involving a warranty dispute, you may wish to contact the Dispute Settlement Board (U.S.).

In some states (in the U.S.) you must directly notify TH!NK Mobility in writing before pursuing remedies under your state's warranty laws. TH!NK Mobility is also allowed a final repair attempt in some states.

In the United States, a warranty dispute must be submitted to the Dispute Settlement Board before taking action under the Magnuson-Moss Warranty Act, or to the extent allowed by state law, before pursuing replacement or repurchase remedies provided by certain state laws. This dispute handling procedure is not required prior to enforcing state created rights or other rights which are independent of the Magnuson-Moss Warranty Act or state replacement or repurchase laws.

THE DISPUTE SETTLEMENT BOARD (U.S. ONLY)

The Dispute Settlement Board is:

- an independent, third-party arbitration program for warranty disputes
- available free to owners and lessees of qualifying TH!NK vehicles

The Dispute Settlement Board may not be available in all states. TH!NK Mobility reserves the right to change eligibility limitations, modify procedures

Customer assistance

and/or to discontinue this service without notice and without incurring obligations per applicable state law.

What kinds of cases does the Board review?

Unresolved warranty repair concerns or vehicle performance concerns as on TH!NK vehicles which are within the terms of any applicable written new vehicle warranty are eligible for review, except those involving:

- a non-TH!NK product
- a non-TH!NK dealership
- sales disputes between customer and dealer except those associated with warranty repairs or concerns with the vehicle's performance as designed
- a request for reimbursement of consequential expenses unless a service or product concern is being reviewed
- items not covered by the New Vehicle Limited Warranty (including maintenance and wear items)
- alleged personal injury/property damage claims
- cases currently in litigation
- vehicles not used primarily for family, personal or household purposes (except in states where the Dispute Settlement Board is required to review commercial vehicles)
- vehicles with non-U.S. warranties

Concerns are ineligible for review if the New Vehicle Limited Warranty has expired at receipt of your application and, in certain states eligibility is dependent upon the customer's possession of the vehicle.

Eligibility may differ according to state law. For example, see the unique brochures for California, West Virginia, Georgia and Wisconsin purchasers/lessees.

Customer assistance

Board membership

The Board consists of:

- three consumer representatives
- a TH!NK dealership representative

Consumer candidates for Board membership are recruited and trained by an independent consulting firm. The dealership Board member is chosen from TH!NK dealership management, recognized for their business leadership qualities.

What the Board needs

To have your case reviewed you must complete the application in the DSB brochure and mail it to the address provided on the application form. Some states will require you to use certified mail, with return receipt requested.

Your application is reviewed and, if it is determined to be eligible, you will receive an acknowledgment indicating:

- The file number assigned to your application.
- The toll-free phone number of the DSB's independent administrator.

Your dealership and a TH!NK Mobility representative will then be asked to submit statements.

To properly review your case, the Board needs the following information:

- Legible copies of all documents and maintenance or repair orders relevant to the case.
- The year, make, model, and Vehicle Identification Number (VIN) listed on your vehicle ownership license.
- The date of repair(s) and mileage at the time of occurrence(s).
- The current mileage.
- The name of the dealer(s) who sold or serviced the vehicle.
- A brief description of your unresolved concern.

Customer assistance

- A brief summary of the action taken by the dealer(s) and TH!NK Mobility.
- The names (if known) of all the people you contacted at the dealership(s).
- A description of the action you expect to resolve your concern.

You will receive a letter of explanation if your application does not qualify for Board review.

Oral presentations

If you would like to make an oral presentation, indicate YES to question 6 on the application. While it is your right to make an oral presentation before the Board, this is not a requirement and the Board will decide the case whether or not an oral presentation is made. An oral presentation may be requested by the Board as well.

Making a decision

Board members review all available information related to each complaint, including oral presentations, and arrive at a fair and impartial decision. Board review may be terminated at any time by either party.

Every effort is made to decide the case within 40 days of the date that all requested information is received by the Board. Since the Board generally meets once a month, it may take longer for the Board to consider some cases.

After a case is reviewed, the Board mails you a decision letter and a form on which to accept or reject the Board's decision. The decisions of the Board are binding on TH!NK (and, in some cases, on the dealer) but not on consumers who are free to pursue other remedies available to them under state or federal law.

Customer assistance

To request a DSB Brochure/Application

For a brochure/application, speak to your dealer or write/call to the Board at the following address/phone number:

Dispute Settlement Board
P.O. Box 5120
Southfield, MI 48086-5120
1-800-428-3718

You may also contact the North American Customer Relationship Center at 1-800-392-3673 (Ford), TDD for the hearing impaired: 1-800-232-5952 or by writing to the Center at the following address:

Ford Motor Company
Customer Relationship Center
16800 Executive Plaza Drive
P.O. Box 6248
Dearborn, Michigan 48121

ORDERING ADDITIONAL OWNER'S LITERATURE

To order the publications in this portfolio, contact Helm, Incorporated at:

HELM, INCORPORATED
P.O. Box 07150
Detroit, Michigan 48207

Or call:

**For a free publication catalog, order toll free:
1-800-782-4356**

Monday-Friday 8:00 a.m. - 6:00 p.m. EST

(Items in this catalog may be purchased by credit card holders only.)

Customer assistance

REPORTING SAFETY DEFECTS (U.S. ONLY)

If you believe that your vehicle has a

Ford Motor Company

defect which could cause a crash or could cause injury or death, you should immediately inform the National Highway Traffic Safety Administration (NHTSA) in addition to notifying TH!NK Mobility.

If NHTSA receives similar complaints, it may open an investigation, and if it finds that a safety defect exists in a group of vehicles, it may order a recall and remedy campaign. However, NHTSA cannot become involved in individual problems between you, your dealer, or TH!NK Mobility.

To contact NHTSA, you may either call the Auto Safety Hotline toll-free at 1-800-424-9393 (or 366-0123 in the Washington D.C. area) or write to:

NHTSA

U.S. Department of Transportation
Washington, D.C. 20590

You can also obtain other information about motor vehicle safety from the Hot-line.

Warranty information

Your satisfaction is our #1 goal. If you have questions or concerns with your TH!NK vehicle, we suggest you follow these steps:

1. Contact your Sales Representative or Service Advisor at your selling/servicing dealership.
2. If the inquiry or concern remains unresolved, contact the Sales Manager or Service Manager at the dealership.
3. If the inquiry or concern cannot be resolved at the dealership level, please contact the TH!NK Mobility Customer Relationship Center.

In the United States:

TH!NK Mobility

Customer Relationship Center

16800 Executive Plaza Drive

P.O. Box 6248

Dearborn, MI 48121

1-800-252-4221

TDD for hearing impaired:

1-800-232-5952

INTRODUCTION

Ford Motor Company and your selling dealer thank you for selecting one of our quality products. Our commitment to you and your TH!NK vehicle begins with quality protection and service.

When you need warranty repairs, your selling dealer would like you to return to it for that service, but you may also take your TH!NK vehicle to another TH!NK dealership authorized for warranty repairs. Certain warranty repairs require special training though, so not all dealers are authorized to perform all warranty repairs. That means that, depending on the warranty repair needed, the TH!NK vehicle may need to be taken to another dealer. If a particular dealership cannot assist you, then contact the Customer Relationship Center at 1-800-252-4221.

Warranty information

This chapter explains in detail the warranty coverages that apply to your 2002–model TH!NK vehicle. If you bought a previously owned 2002–model TH!NK vehicle, you are eligible for any remaining warranty coverages.

Ford Motor Company or Ford Motor Vehicle Assurance Company (a subsidiary of Ford Motor Company, The American Road, Dearborn, MI 48121) provides the **New TH!NK Vehicle Limited Warranty**. See the section titled **The New TH!NK Vehicle Limited Warranty** for your 2002–model TH!NK vehicle in this chapter.

If you are interested in knowing whether the warranty coverage is provided by Ford Motor Company or Ford Motor Vehicle Assurance Company, call the Customer Relationship Center at 1–800–252–4221. The warranty coverage you receive and your dealer’s handling of any warranty covered repair will be the same regardless of the warranty provider.

IMPORTANT INFORMATION YOU SHOULD KNOW

If you need customer assistance

Your TH!NK dealer is available to assist you with all your automotive needs. Please follow the procedures outlined at the beginning of this chapter.

Know when your warranty begins

Your **Warranty Start Date** is the day you take delivery of your new TH!NK vehicle or the day it is first put into service (for example, as a dealer demonstrator), whichever occurs first.

Warranty information

Check your TH!NK vehicle

We try to check TH!NK vehicles carefully at the assembly plant and the dealership, and we usually correct any damage to paint, body panels, upholstery, or other appearance items. But occasionally something may slip past us, and a customer may find that a vehicle was damaged before he or she took delivery. If you see any damage when you receive your vehicle, notify your dealership within one week.

Maintain your TH!NK vehicle properly

Your glove compartment contains an **Owner's Guide** which indicates the scheduled maintenance required for your TH!NK vehicle. Proper maintenance guards against major repair expenses resulting from neglect or inadequate maintenance, and may help increase the value you receive when you sell or trade your Think vehicle.

It is your responsibility to make sure that all of the scheduled maintenance is performed and that the materials used meet TH!NK engineering specifications. Failure to perform scheduled maintenance as specified in the Owner's Guide will invalidate warranty coverage on parts affected by the lack of maintenance. Make sure that receipts for completed maintenance work are retained with the vehicle and confirmation of maintenance work is always entered in your **Owner's Guide**.

Your TH!NK dealership has factory-trained technicians who can perform the required maintenance using genuine TH!NK parts. The dealership looks forward to meeting your every service need to maximize your satisfaction with your TH!NK vehicle.

Warranty information

Who pays for warranty repairs?

You will not be charged for covered warranty repairs made during the warranty periods for Bumper to Bumper, Safety Restraint, or Corrosion.

You will not be charged for repairs to defective batteries during the first 12 months after the warranty start date.

Your battery is covered on a customer-participation basis after the first 12 months in service.

Some states have mandated alternate time coverage periods for parts of your vehicle (e.g. seatbelts).

Some states and/or local governments may require a tax on a portion of warranty repairs. Where applicable law allows, the tax must be paid by you, the owner of the vehicle.

During the Bumper to Bumper Warranty period, dealers may receive instructions to provide no-cost, service-type improvements-not originally included in your Owner's Guide- intended to increase your overall satisfaction with your vehicle.

Sometimes TH!NK may offer a special adjustment program to pay all or part of the cost of certain repairs beyond the terms of the applicable warranty. Check with your dealer or call **1-800-252-4221** to learn whether any adjustment program is applicable to your TH!NK vehicle. Please have your vehicle identification number available.

Warranty information

THE NEW TH!NK VEHICLE LIMITED WARRANTY FOR YOUR 2002–MODEL TH!NK VEHICLE

Your NEW TH!NK VEHICLE LIMITED WARRANTY gives you specific legal rights. You may have other rights that vary from state to state. The New TH!NK Vehicle Limited Warranty is the only express warranty applicable to your TH!NK vehicle. Neither Ford Motor Company or Ford Motor Vehicle Assurance Company assumes nor authorizes anyone to assume for it any other obligation or liability in connection with your TH!NK vehicle or this warranty.

Ford Motor Company, Ford Motor Vehicle Assurance Company and your dealer are not responsible for any time that you lose, for any inconvenience you might be caused, for the loss of your transportation, or for any other incidental or consequential damages you may have.

You may have some implied warranties. For example, you may have:

- an implied warranty of merchantability (that the TH!NK vehicle is reasonably fit for the general purpose for which it was sold); or
- an implied warranty of fitness for a particular purpose (that the TH!NK vehicle is suitable for your special purposes.)

These implied warranties are limited, to the extent allowed by law, to the time period covered by the written warranties, or to the applicable time period provided by state law, whichever period is shorter.

Some states do not allow Ford Motor Company or Ford Motor Vehicle Assurance Company to limit how long an implied warranty lasts or to exclude or limit incidental or consequential damages, so the limitation and exclusions described above may not apply to you.

Note: If you are an eligible U.S. owner and have a warranty concern unresolved by your dealer, you may use the services of the Dispute Settlement Board. See the Dispute settlement board in the *Customer assistance* chapter.

Warranty information

Quick Reference: Warranty Coverage

This chart gives a general summary of your warranty coverage provided by Ford Motor Company or Ford Motor Vehicle Assurance Company under the **New TH!NK Vehicle Limited Warranty**. Please refer to the description of warranty coverage for more specific information.

For more details on coverage, see *What is covered* and *What is not covered* in this chapter.

Type of Coverage	Years in Service	Miles
Bumper to Bumper	3 years	Unlimited miles
Battery	3 years*	Unlimited miles
Safety Restraint	5 years	Unlimited miles
Corrosion	5 years	Unlimited miles

* Customer participation (pro-rated coverage) after 12 months (regardless of miles driven). See details of battery coverage for percentage Ford will pay.

What is covered

The **New TH!NK Vehicle Limited Warranty** coverage is provided by Ford Motor Company or Ford Motor Vehicle Assurance Company, a subsidiary of Ford Motor Company. These coverages include Bumper to Bumper Coverage, Battery Coverage, Safety Restraint Coverage, and Corrosion Coverage.

Bumper to Bumper Coverage

Under your New TH!NK Vehicle Limited Warranty, Bumper to Bumper Coverage begins at the warranty start date and lasts for three years regardless of miles driven. During this coverage period, authorized TH!NK dealers will repair, replace, or adjust all parts on your TH!NK vehicle that are defective in factory-supplied materials or workmanship. Items or conditions that are not covered by the New TH!NK Vehicle Limited Warranty are described in *What's not covered* in this chapter.

Warranty information

When making warranty repairs on your TH!NK vehicle, the dealer will use TH!NK parts or remanufactured or other parts that are authorized by TH!NK. In certain instances, TH!NK may authorize repairs at other than TH!NK dealer facilities.

Battery Coverage

Under your New TH!NK Vehicle Limited Warranty, full battery coverage begins on the warranty start date and lasts for 12 months. During this time period, Ford Motor Company or Ford Motor Vehicle Assurance Company warrants your TH!NK vehicle's battery against defects in factory supplied materials or workmanship. After the first 12 months in service (until the 36 month regardless of miles driven), a defective battery will be replaced on a customer-participation basis:

- For the 13th month through 18th month in service, Ford Motor Company will pay 60% of the cost of the replacement battery.
- For the 19th month through 24th month of service, Ford Motor Company will pay 40% of the cost of the replacement battery.
- For the 25th month through 30th month of service, Ford Motor Company will pay 20% of the cost of the replacement battery.
- For the 31st month through 36th month of service, Ford Motor Company will pay 10% of the cost of the replacement battery.

The percentage Ford Motor Company will pay is applied to the present suggested retail price of the new replacement battery for your TH!NK vehicle.

Labor required to test and replace a defective battery has full coverage under the terms of the Battery Warranty. Towing, if needed, is covered under the terms of the Roadside Assistance Program. See *Roadside Assistance* in this chapter.

Warranty information

Safety Restraint Coverage

Under your New TH!NK Vehicle Limited Warranty, Safety Restraint Coverage begins at the warranty start date and lasts for five years regardless of miles driven.

During this coverage period, Ford Motor Company or Ford Motor Vehicle Assurance Company warrants your TH!NK vehicle's safety belts against defects in factory-supplied materials or workmanship.

Corrosion Coverage

Under your New TH!NK Vehicle Limited Warranty, Corrosion Coverage begins at the warranty start date and covers body panels against corrosion due to a defect in factory-supplied materials or workmanship. Corrosion Coverage (which lasts for 5 years, regardless of miles driven) only applies if the corrosion causes perforation (holes) in body panels.

If corrosion does not cause perforation (holes), and is not the result of usage and/or environmental conditions, paint damage is covered under the terms of the Bumper to Bumper Warranty (3 years regardless of miles driven).

For damage caused by airborne material (environmental fallout) — where there is no factory related defect involved and therefore no warranty, our policy is to cover paint damage due to airborne material for 12 months.

What is not covered

Damaged caused by:

- accidents, collision or objects striking the TH!NK vehicle
- theft, vandalism, or riot
- freezing
- fire or explosion
- misusing the TH!NK vehicle, such as driving over curbs, overloading or racing

Warranty information

- altering or modifying the TH!NK Vehicle — including the body, chassis, or components — after the TH!NK Vehicle leaves TH!NK's Mobility's control
- non-TH!NK parts installed after the TH!NK vehicle leaves TH!NK's Mobility's control
- tampering with the TH!NK vehicle
- using contaminated or improper fluids
- customer-applied chemicals or accidental spills
- driving through water deep enough to cause electrical system damage

Damage caused by use and/or the environment

Your New TH!NK Vehicle Limited Warranty does not cover surface rust and deterioration of paint, trim, upholstery, and other appearance items that result from use and/or exposure to the elements. Here are examples:

- stone chips, scratches (some examples are on paint and glass)
- dings, dents
- cuts, burns, punctures or tears
- road salt, tree sap
- bird and bee droppings
- lightning, hail
- windstorm
- earthquake
- water or flood

Damage caused by improper maintenance

Your New TH!NK Vehicle Limited Warranty does not cover damage caused by failure to maintain the TH!NK vehicle, improperly maintaining the TH!NK vehicle, or using the wrong part, oil, lubricants, or fluids. See the *Maintenance and specifications* chapter for the correct fluid types and levels and for proper ways to maintain your TH!NK vehicle.

Warranty information

Maintenance/wear

Your New TH!NK Vehicle Limited Warranty does not cover:

1. parts and labor needed to maintain the TH!NK vehicle; and
2. the replacement of parts due to normal wear and tear.

You, as the owner, are responsible for these items. Examples are:

- lubricants, other fluids
- brake linings/pads
- tire rotation
- cleaning/polishing
- wiper blades

Tire wear or damage

Normal wear or worn-out tires are not covered by the New TH!NK Vehicle Limited Warranty. Road hazard damage such as cuts, snags, bruises, bulges and impact breaks (potholes and curbs) are not covered. Any damage caused by a puncture or tire repair is not covered. In addition, damage from improper inflation or alignment, tire chains, racing, spinning (as when stuck in snow or mud), improper mounting or dismounting is not covered.

Other items and conditions not covered

Your New TH!NK Vehicle Limited Warranty does not cover:

- non-Ford parts of your TH!NK vehicle, for example, parts (including glass) installed by body builders or manufacturers other than Ford Motor Company
- TH!NK vehicles that have ever been labeled or branded as “dismantled” “fire,” “flood,” “junk,” “rebuilt,” “reconstructed,” or “salvaged”; this will void the New TH!NK Vehicle Limited Warranty
- TH!NK vehicles that have been determined to be a “total loss” by an insurance company; this will void the New TH!NK Vehicle Limited Warranty

Warranty information

Time limits on coverage

- After the first 12 months in service, wheel alignment and tire balancing are not covered unless required by a warranty repair.

ROADSIDE SERVICE ASSISTANCE

Roadside Service Assistance

Your vehicle is covered by the complimentary Ford Roadside Assistance Program (unless you are driving a daily rental unit). Under this program Ford will cover:

- towing to the nearest TH!NK dealership, or towing to your selling dealership if within 60 miles

The Roadside Assistance Program is separate from the New TH!NK Vehicle Limited Warranty, but the program's time period runs concurrently with Bumper to Bumper Warranty Coverage (three years regardless of miles driven). If you need towing after Bumper to Bumper coverage has ended, Ford can arrange roadside assistance and charge your credit card unless the problem is covered by another TH!NK warranty. Ford will pay the tow charge under the other warranty.

For emergency roadside assistance, call **1-800-252-4221, 24 hours a day, 365 days a year.**

For daily rental units that must be towed because a covered part has failed during the Bumper to Bumper warranty period, Ford will cover towing to the nearest Ford Motor Company dealership.

Warranty information

STATE WARRANTY ENFORCEMENT LAWS

These state laws — sometimes called “lemon laws” — allow owners to receive a replacement THINK vehicle or a refund of the purchase price, under certain circumstances. The laws vary from state to state.

To the extent your state law allows, Ford Motor Company requires that you first send us a written notification of any defects or non-conformities that you have experienced with your THINK vehicle. (This will give us the opportunity to make any needed repairs before you pursue the remedies provided by your state’s law.)

In all other states where not specifically required by state law, Ford Motor Company requests that you give us the written notice.

Send your written notification to:

Ford Motor Company
Customer Relationship Center
16800 Executive Plaza Drive
P.O. Box 6248
Dearborn, MI 48121

A

- Audio system
(see Radio) 29
- Automatic transaxle
 fluid, refill
 capacities 92
 fluid,
 specification 92
- Auxiliary power
point 27

B

- Ball and club
washer 31
- Batteries 84
- Batteries -
flooded type 86
- Batteries -
maintenance free 88
- Brakes
 fluid, checking
 and adding 88
 fluid, refill
 capacities 92
 fluid,
 specifications 92
 lubricant
 specifications 92
 parking 66
- Brakes - dual circuit
brake system 67
- Brakes - regenerative
brake system 67
- Break-in period 2

C

- Capacities for
refilling fluids 92
- Certification Label 96
- Changing a tire 77
- Charging 66, 69, 73
- Child safety
restraints 51
 child safety belts 51
- Child safety seats 52
 attaching with
 tether straps 55
 in front seat 53
 in rear seat 53
 LATCH 58
- Cleaning your vehicle
 exterior lamps 82
 instrument
 cluster lens 82
 instrument panel 82
 interior 83
 safety belts 82
 washing 81
 waxing 81
 wheels 82
- Coolant
 refill capacities 92
 specifications 92
- Cooler 32
- Cupholder(s) 26
- Customer Assistance
 Ordering additional
 owner's literature . 101
 The Dispute
 Settlement Board ... 97

Index

E

Engine
lubrication
specifications 92
refill capacities 92

Engine oil
refill capacities 92
specifications 92

F

Floor mats 29

Fluid capacities 92

Fuel
capacity 92

Fuses 75–76

G

Gauges 4

Golf rack 28

H

Hazard flashers 75

Head restraints 45

Headlamps 12
aiming 14
bulb specifications .. 22
replacing bulbs 15
turning on and off .. 12

I

Ignition 60

Infant seats
(see Safety seats) 52

J

Jack 77
positioning 77

K

Keys
positions of the
ignition 60

L

Lamps
bulb replacement
specifications
chart 22
headlamps 12
replacing
bulbs 15, 19–21

Lane change indicator
(see Turn signal) 14

Lights, warning and
indicator 4

Limited warranty 107

Lubricant
specifications 92

M

Maintenance and
Care 93–94

Mirrors 27
side view mirrors
(manual) 28

Motorcraft parts 91

P

- Parts (see Motorcraft parts) 91
- Power steering
 - fluid, refill capacity 92
 - fluid, specifications 92

R

- Radio 29

S

- Safety belts (see Safety restraints) 46–48
- Safety defects, reporting 102
- Safety restraints 46–48
 - cleaning the safety belts 50, 82
 - extension assembly 50
 - for adults 48
 - for children 51
- Safety seats for children 52
- Sand and seed bottle 30
- Scorecard holder 29
- Seat belts (see Safety restraints) 46
- Seats 45
 - child safety seats ... 52
- Specification chart, lubricants 92

- Starting your vehicle 60, 62
- Sunroof (moonroof) 25
- Sweater basket 33
- Sweater net 33

T

- Tires 90
 - checking the pressure 90
 - replacing 91
 - rotating 90
- Tires - servicing 90
- Transaxle
 - fluid, refill capacities 92
 - lubricant specifications 92
- Trunk expander 34
- Turn signal 14

V

- Vehicle cover 44
- Vehicle dimensions ... 94
- Vehicle Identification Number (VIN) 96

W

- Warning lights (see Lights) 4
- Warranty coverage 108
- Warranty enforcement laws 114

Index

- Warranty information 103–106
- Washer fluid 24
- Waxing your vehicle 81
- Weather enclosure 34, 41, 44
- Windows
 - rear wiper/washer ... 23
- Windshield washer fluid and wipers
 - checking and cleaning 24
 - operation 23
- Wrecker towing 79